

GRADUATION EXERCISE

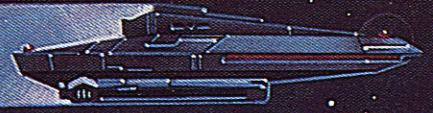

An adventure for use with
STAR TREK[®]
THE ROLE PLAYING GAME



© David K. Leitch '85

FASA
CORPORATION

GRADUATION EXERCISE

Table Of Contents

<p>INTRODUCTION 2</p> <p> Plot Synopsis 2</p> <p> Contents of This Book 2</p> <p>THE ADVENTURE 3</p> <p> Awaiting Assignment 3</p> <p> The Mission Plan 3</p> <p> Preparing For Departure 4</p> <p> Aboard The <i>Excisor</i> 4</p> <p> Plan of Action 5</p> <p> The Touchdown Point 5</p> <p> On Tarab VI 5</p> <p> Snow and Ice 5</p> <p> The Agent's Camp 5</p> <p> Romulan Experiments 6</p> <p> New Hope 6</p> <p> Race Against Time 6</p> <p> Mission Accomplished 6</p> <p> Graduation Night 6</p> <p>BACKGROUND INFORMATION. 7</p> <p> Academy Days 7</p> <p> The First Year 7</p> <p> Second Year 8</p> <p> Third Year 8</p> <p> Fourth Year 9</p> <p> Master of Cadets Kameron 9</p> <p> Computer Files 9</p> <p> Tarab VI 9</p> <p> Native Life-Forms 10</p> <p> Computer Searches 11</p> <p>MAPS 12</p> <p> Tarab VI Search Area 12</p> <p> Romulan Research Center 12</p> <p> The Power Plant 12</p> <p> Living Quarters 12</p> <p> The Research Lab 15</p> <p> The Computer Center 15</p> <p> Pits 15</p>	<p>VESSELS 16</p> <p> <i>Excisor</i> 16</p> <p> Quartermaster Section 17</p> <p>CAST OF CHARACTERS 18</p> <p> Cadet Exercise Group 473 18</p> <p> Major NPCs 23</p> <p> Additional NPCs 26</p> <p>GAMEMASTER'S NOTES 28</p> <p> Hints on Play 28</p> <p> Timeline 28</p> <p> Points of View 29</p> <p> The Major Participants 30</p> <p> Commander Kameron 30</p> <p> Kyrstallia Stallamaine 30</p> <p> Trevallis and the Preserver Stone 31</p> <p> Romulan Security and Defense 32</p> <p> Inside the Romulan Base 32</p> <p> The Romulan Defense 32</p> <p> Random Encounters and Events 33</p> <p> Satellite Outpost 2 33</p> <p> Aboard the <i>Excisor</i> 33</p> <p> On Tarab VI 34</p> <p> Animal Encounters 35</p> <p> Tarab VI 35</p> <p> Search Area 35</p> <p> Krystallia's Camp 36</p> <p> Judging the Equipment 36</p> <p> Judging Player Performance 39</p> <p> Guidelines 39</p> <p> Evaluation Results 39</p> <p> Possible Rewards 39</p> <p> Potential Outcomes 40</p> <p> Adapting to Ongoing Campaigns 40</p> <p> Altering Group Composition 40</p> <p> Security Reports 40</p> <p> Future Assignment 40</p> <p> Designer's Notes 40</p>
--	--

<p>Writing</p> <p style="padding-left: 20px;">Bernard Edward Menke</p> <p style="padding-left: 20px;">Rick David Stuart</p> <p>Editorial Staff</p> <p style="padding-left: 20px;"><i>Editor-In Chief</i></p> <p style="padding-left: 40px;">L. Ross Babcock III</p> <p style="padding-left: 20px;"><i>Senior Editor</i></p> <p style="padding-left: 40px;">Donna Ippolito</p> <p style="padding-left: 20px;"><i>Editor</i></p> <p style="padding-left: 40px;">Todd Huettel</p>	<p>Production Staff</p> <p style="padding-left: 20px;"><i>Cover Art</i></p> <p style="padding-left: 40px;">David R. Deitrick</p> <p style="padding-left: 20px;"><i>Illustration</i></p> <p style="padding-left: 40px;">Dana Knutson</p> <p style="padding-left: 40px;">Todd F. Marsh</p> <p style="padding-left: 40px;">Jane Bigos</p> <p style="padding-left: 20px;"><i>Layout</i></p> <p style="padding-left: 40px;">Tara Gallagher</p>
--	--

To all those brave enough to try:
Win or lose.

Introduction

Graduation Exercise is an adventure designed for use with *STAR TREK: The Role Playing Game*. It is intended for a group of up to six players adopting the roles of cadets in their last year at the Imperial Klingon Star Academy. The outcome of this open-ended adventure is determined solely by the actions of the player characters.

The adventure begins as the cadets are completing the last of four years of grueling, often brutal training at the Academy. With the end now in sight, they look forward eagerly to assuming the duties of commissioned officers in the Imperial Klingon Navy. One final test remains, however. Those who succeed in the final exercise will graduate to become midshipmen assigned to their cadet cruise. Those who fail are likely to meet their death instead.

PLOT SYNOPSIS

In **Awaiting Assignment**, the cadets in Exercise Team 473 are gathered on Klingon Satellite Outpost 2, where they learn that their Cadet Task Master and exercise evaluator is Commander Kameron sutai Rannic, a naval officer with a distinguished service record as well as a reputation for cruelty. When Kameron arrives, he presents each cadet with a copy of the **Mission Plan** outlining their assignment.

Their mission is to locate and retrieve an Imperial agent named Kyrstal from Tarab VI, a small planet in the Triangle. The cadets note with surprise that this a classified, tight-security assignment. Also, they learn that although Commander Kameron is nominally in charge of the exercise and will accompany the players to Tarab VI, the mission is a test solely of the cadets' skills and abilities.

The *Excisor*, a K-26 escort vessel, transports Exercise Team 473 and Commander Kameron to Tarab VI, a glacial world in the Triangle Zone, near Romulan space. **Aboard the Excisor**, the cadets will have the chance to review available resources and formulate a **Plan of Action**. Although Imperial Security has only a general idea of where the intelligence agent is located on the planet, the cadets consult a map specially prepared for them by the *Excisor's* cartographer. They narrow down their area of search to three possible sites.

During the flight, the player characters may also consult the *Excisor's* **Computer Files** for information on the climate and life-forms of Tarab VI. Once in orbit around the planet, the ship's sensors indicate the presence of numerous life-forms but nothing corresponding to the missing agent. Pinpointing the most likely area in which the agent's camp may be found (**Touchdown Point**), the player characters make their descent to Tarab's snow-covered surface, and begin their search.

On **Tarab VI**, Exercise Team 473 finds that their mission is not as straightforward as might first have seemed. Tarab is in the midst of a global ice age, and its cold, frozen surface makes ground operations difficult at best (**Snow and Ice**). Contact with native Tarab life-forms proves equally hazardous, as does detection of a strange virus in the planet's soil and water.

When the cadets do locate **The Agent's Camp**, they find signs of a struggle and surprising indications of the presence of Romulans on the planet. A wider search around the campsite discloses the direction in which Kyrstal may have been taken. Following the trail, the player characters discover the entrance to the Romulans' base on Tarab VI (**Romulan Experiments**). Here, the Scientist Trevallis is attempting to create a serum crucial to the Romulans, and his experiments are based on a mysterious inscription discovered on an ancient Preserver artifact.

In **Race Against Time**, the stakes have suddenly been raised. The players must escape with both the Klingon agent and proof of the Romulans' clandestine activities on Tarab VI. The Romulans are well-defended, and prepared to die before giving up evidence about their secret researches.

If the cadets succeed in their graduation exercise, not only can they look forward to becoming officers in service of the *Komerex*, but there is the promise of personal glory and rapid advancement. An ignominious death awaits those who fail.

CONTENTS OF THIS BOOK

This booklet contains all the information needed to play **Graduation Exercise** to its completion.

The Adventure section outlines the cadets' mission, explains the presence of the Romulans on Tarab VI, and describes the steps needed to solve the mystery of the agent Kyrstal's disappearance.

There is **Background Information** for use by the players. It includes a complete description of each year in a cadet's life at the Imperial Klingon Star Academy. There is also data on Tarab VI and its native life-forms. The **Vessels** chapter describes the *Excisor* in full, and includes a Quartermaster Section on the equipment available for the players' use. There are also detailed **Maps** of both the Search Area and the Romulan Research Center on Tarab VI.

Cast of Characters provides complete game statistics for six pre-generated player characters as well as for major and minor NPCs.

Finally, the chapter on **Gamemaster's Information** offers hints for play, supplementary background information for the gamemaster's use only, tables for random encounters and events, and guidelines for rating player performance during the adventure. There are also suggestions for incorporating this adventure into an on-going campaign.

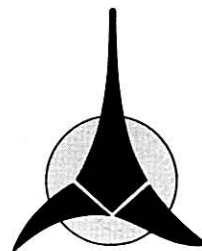

The Adventure

*Only dead Klingons can afford to make assumptions.
Ancient Klingon Proverb*

AWAITING ASSIGNMENT

As the adventure begins, the player characters are assembled in the spacious Visiting Officers lounge on Klingon Satellite Outpost 2. The satellite orbits the planet K'Tazza VI, near the border between the Klingon and Romulan Empires. The players are all cadets from the Imperial Star Command Academy, which sent them here several days ago. They are presently enjoying the last comforts any of them will know until completion of their graduation exercise. All the cadets are from the same academic training battalion, although several were previously in different training groups.

The cadets are now awaiting arrival of their Cadet Task Master, who has yet to be introduced. During this wait, they will probably discuss the years leading up to this crucial moment, as well as assess each other's strengths and capabilities in relation to the upcoming ordeal. With unaccustomed hospitality, the Post Commander has provided the fledglings with a sumptuous 'last meal', in which they indulge happily.

After the player characters have had an opportunity to relax and get acquainted, they will be joined by Commander Kameron sutai Rannic. None of the cadets will be happy about the selection of this officer as their exercise evaluator. Each of them has had some occasion to run afoul of Kameron at the Academy, and the memories still rankle. Although Kameron will attempt to seem open and friendly, laughing and joking with the group, he is well-known for his cruelty and viciousness.

Having introduced himself, Kameron will pass out to each cadet a sealed packet containing a copy of the Mission Plan of their graduation exercise. The player characters will then retire to quarters to examine the briefing packets in detail and to make ready for the ordeal to come.

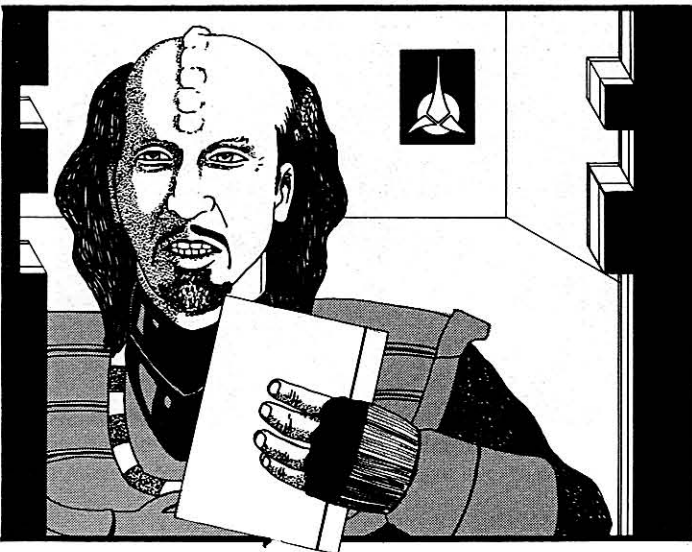

THE MISSION PLAN

Each player character must carefully review the Mission Plan to be sure he fully understands the significance of each detail:

Imperial Security Directive 45789-C
Imperial Training Division Sub-Section Beta - 41
Classified Material - Priority Alpha - 2
Eyes Only: Cadet Exercise Group 473

Upon receipt of this document, the cadets of Exercise Team 473 will place themselves immediately under the command of the officer designated as Duty Task Master for the duration of this assignment. Each cadet will carry out the following orders under conditions of Security Condition Alpha-2. Any deviation from the following instructions will constitute an act of treason, grounds for immediate termination.

Specification 1:

After reporting to the Duty Task Master, Exercise Team 473 will be delivered to a target designation via Imperial transport, to be provided for the duration of this mission.

Specification 2:

Target designation is the planet Tarab VI, Triangle space. This planet lies in the region jointly claimed by the Komerex and the Romulan Star Empire. Once in orbit around the target designation, the team will take whatever actions necessary to first locate and then secure the safe return of an intelligence operative on the planet's surface.

This operative has information vital to Imperial Star Command. The operative is identified by the code name "Kyrstal".

Specification 3:

After securing the operative, departure from the target designation will take place 48 standard hours after descent from orbit has been achieved. No delays will be tolerated.

Specification 4:

Cadets will receive no assistance from their Duty Task Master during the course of this assignment. Those who discharge their duty in an acceptable manner will be given a favorable commendation to their respective review board upon completion of this mission.

Specification 5:

For reasons of security, all members of this mission group will be considered expendable.

In reviewing the Mission Plan, the player characters will quickly come to realize that theirs is no ordinary assignment. The Priority Alpha-2 security designation identifies this as a classified operation. Therefore, any discussion of the Mission Plan (either before or after completion) with anyone but fellow party members will be considered a direct violation of Imperial Security directives, punishable by immediate termination by Task Master Commander Kameron.

Once on the planet Tarab VI, the group of cadets will have two standard days in which to locate the missing operative known only as Kyrstal. After the exercise has begun, the players can expect no assistance from their Task Master in their efforts to ensure the safe return of the intelligence operative. Acting solely as observer and evaluator, Kameron can provide information upon request but nothing in the way of direct aid. The players must deal with the mission as best they know how. Should complications arise, successful completion of the mission has priority over all other considerations.

PREPARING FOR DEPARTURE

After their meeting with Kameron, the players will be left to make any last preparations before their mission formally begins at 0500 hours local time the next day. Aware now of the importance of the mission, each cadet will interpret the directives as he sees fit. For a Klingon, that means he is expected to carry out whatever actions necessary to achieve the mission objective, at the same time seeking the maximum personal glory. The players will need to formulate a plan of action, but each individual must decide how best to turn events to his advantage.

Transportation for the cadets is being provided by the *Excisor*, a K-26 escort on temporary detached service to Satellite Outpost 2, and currently housed in one of the base's huge hangar bays. Player characters will have approximately ten hours before they must report aboard. In the time remaining, the cadets will be allowed to board ship ahead of time to store personal belongings and acquaint themselves with the new surroundings. They may employ their *Bribery* skills to obtain information concerning the upcoming voyage and Tarab VI from star base personnel.

Regulation provisions for the journey can be drawn from the base's Quartermaster Section. As the Captain of the *Excisor* has no intention of wasting his ship's precious stores on "wretched scum", the cadets will need rations for the journey to and from Tarab as well as survival rations for consumption while on-planet. It is the responsibility of each cadet to acquire his own supplies prior to departure. All other supplies, such as cold-weather gear and personal weapons, will be provided from ship's stores, subject to availability and player preferences.

Prior to lift-off, the player characters may also attempt to secure other, unauthorized materials from any starbase personnel willing to deal with them. For the right price, they can obtain precious consumables from base personnel. (As cadets do not receive service pay during their Academy training, it will be difficult but not impossible for them to arrange to obtain 'unofficial' goods or services. Although theft is not encouraged as a means of increasing one's chance of survival, a cadet would not entirely dismiss the possibility.)

However the players choose to spend the ten hours before departure, each will be transferred under close guard to the *Excisor's* hangar bay at 0500 the following morning. The *Excisor* will depart Satellite Outpost 2 under security blackout. Once the group is on board, there will be no further communications with base personnel.

ABOARD THE *EXCISOR*

Aboard the *Excisor*, the cadets are quartered among the enlisted ranks, many of whom are not pleased to share their meager comforts with future "Thought Ensigns". Due to space limitations, the player characters will have to double up with a partner for the duration of the journey. (Let the players decide on these arrangements among themselves.) Commander Kameron will be quartered with the ship's junior officers, meeting with the cadets each day to observe and evaluate their actions.

The voyage to the Tarbus system takes approximately six standard days, during which the players are expected to pull their share of duty aboard ship. Shortly after lift-off, each player character will be assigned to the department best suited to his special skills, and expected to stand a watch during the day under the supervision of a senior ship's officer. The player characters can work out these duty schedules among themselves. When not on duty, each player character has free run of the ship, with the exception of that portion known as "Officer's Country". In their spare time, the cadets can interact with ship's personnel (the majority of whom are Klingon/Human Fusions), or attempt to prepare themselves for the mission.

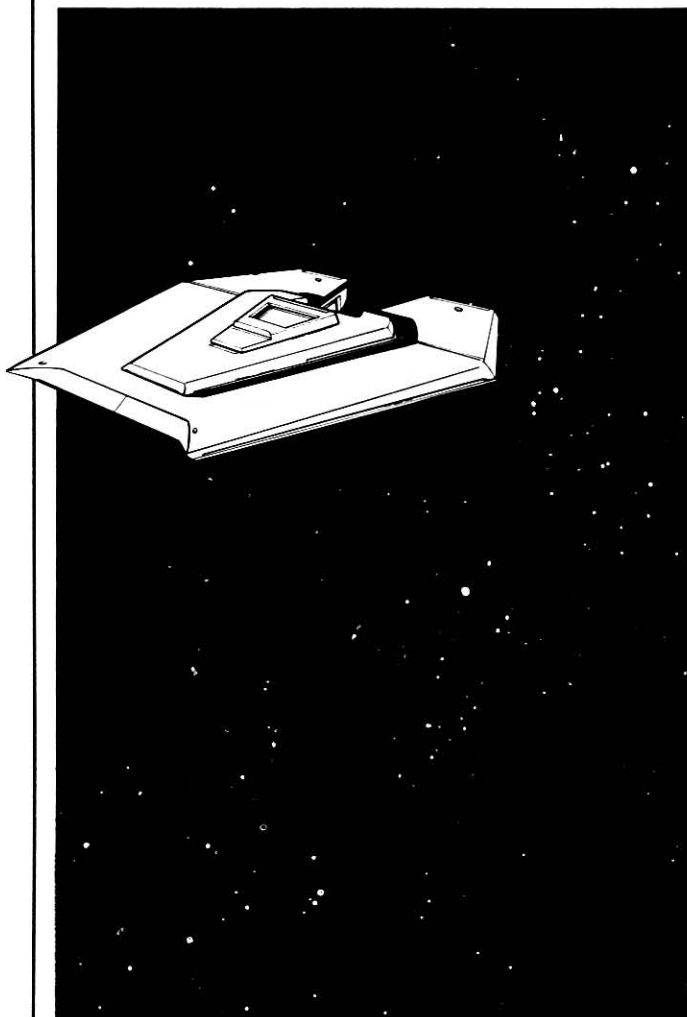

PLAN OF ACTION

Prior to arrival in orbit around Tarab VI, the players must come to a mutually-agreed-upon course of action (as well as potential contingency plans) that will go into effect once they arrive on the planet. It is not so important that a single individual be appointed leader of the group as it is for each to understand what they are up against and what is expected of them. Again, the coordinating of individual efforts is left entirely to the players' discretion.

In finalizing their plans, the players can consult the ship's computer banks for any potentially valuable information about Tarab or other aspects of their mission. Extracting such information, however, will depend on the individual players' *Computer Operation* skills. *Excisor* personnel will be under strict orders not to assist the players in their efforts, though none will try to hinder them deliberately. The cadets may also approach Commander Kameron with specific questions regarding their situation. This is the only assistance the Commander is obligated to provide, and then only if specifically asked for it.

As the *Excisor* approaches the Tarbus system, the player characters may try to learn more about Tarab VI during their duty watches. After orbit around the planet has been achieved, the team of cadets will have three hours to make final preparations before descent to the surface. An unarmed ship's shuttle rather than the ship's transporters will be used for landing on Tarab VI.

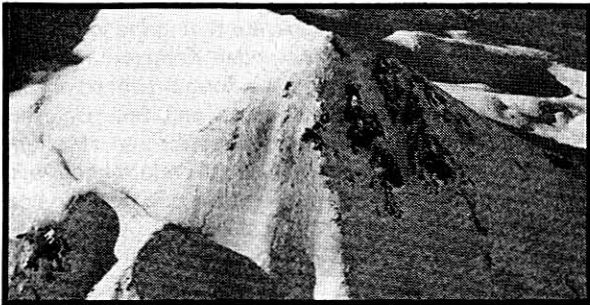

THE TOUCHDOWN POINT

At the start of **Graduation Exercise**, Tarab VI is at the furthest point in its orbit around its sun. Sensor scans indicate that the planet is in the midst of an apparent global ice age. Only the northern hemisphere appears capable of sustaining any form of native life, and that only in selected regions. Sensors will also detect what seem to be energy discharges in the same regions, although it cannot be determined whether these are natural or man-made in origin.

Once final orbit is achieved, Kameron will instruct the ship's cartographers to provide a map of the northern hemisphere for the players' examination. Using this map, the group will determine that Kyrstal's camp is probably located on one of three likely sites, all lying within a narrow band of frozen, rugged terrain. As no other information is immediately available, the players must decide for themselves which site they will investigate first.

Having selected one of the three possible sites, the group will pilot their shuttle to a touchdown point near the chosen location, accompanied by a ship's officer. Having deposited the cadets on-planet, the officer will the shuttle back to the *Excisor*. Within exactly 48 hours, the shuttle will return for the landing party, giving the group exactly five minutes to re-embark before the craft lifts off. Any cadet unable to reach the touchdown point on time will be left behind.

ON TARAB VI

SNOW AND ICE

Once the player characters have landed and debarked, they find themselves alone amidst harsh and bleak surroundings. Their investigations will cover a 20-kilometer radius of sparsely-vegetated tundra that changes to small hills and low mountain ranges as one proceeds west. The planet's surface is covered with several inches of snow, ice, and drifts up to three meters high, with no sign of humanoid habitation. Though animal life-forms are known to exist on Tarab, none will be immediately evident.

Because the planet is so distant from its parent star, the Tarabian sun looks like a small, bluish-white disk lying low on the horizon. The thin atmosphere of Tarab sharpens images dramatically, painfully intensifying the glare off the planet's frosted surface. Temperatures in the region of the cadet's mission range from a daytime high of -5°C (20°F) to a chilly -35°C (-30°F) at night.

THE AGENT'S CAMP

Depending on the site chosen for their touchdown point, the player characters may find themselves either very near Kyrstal's camp or facing a long trek to the next likely spot. In either case, once the group reaches the actual camp site, a quick survey of the agent's last habitation reveals evidence of a recent fight. The camp itself will be in ruins, and there are scorch marks on surface ice and stones, indicating that energy weapons were used. Even more important is the discovery of a dead Romulan, although there is no clue to why he was on Tarab.

Having determined that there are no other life-forms present, the player characters may begin sifting through the camp's remains for clues to what happened here. While searching, one of the cadets will stumble upon a personal tracer. This device will allow them to track Kyrstal to where she is held captive by the Romulans.

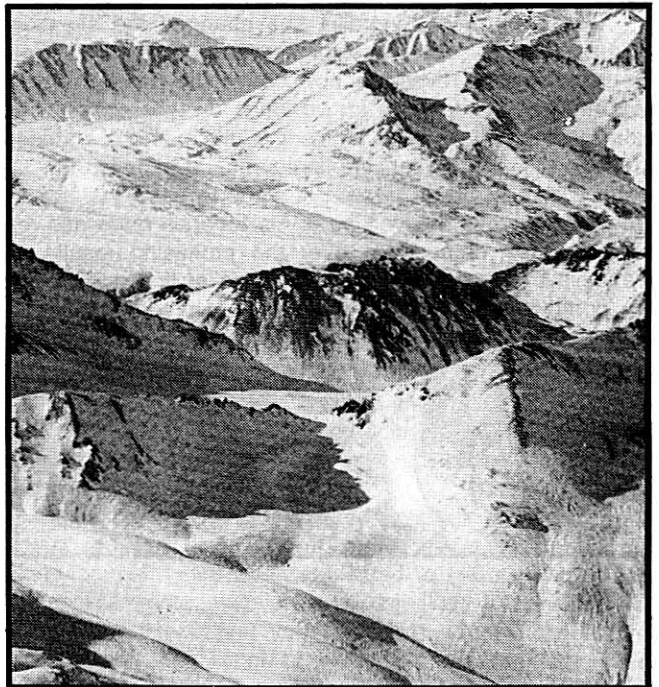

ROMULAN EXPERIMENTS

Long before the arrival of Exercise Team 473 on Tarab VI, Trevallis and his Romulan research team had established themselves on the planet. Their laboratories, living accommodations, and computer facilities lie within and near a large cave. At some risk, Trevallis' security teams are constantly at work gathering native life-forms suitable for use in his experiments.

Trevallis is seeking to develop a serum capable of stimulating an increased reproductive rate in animals. The serum would be based on inscriptions discovered on an ancient Preserver artifact. If properly controlled, such a serum would be of immense aid in supplying food to the resource-poor Romulan populations.

Up till now, Trevallis has been unable to decipher the Preserver Stone inscriptions, which he believes to be chemical formulas. Experimentation with native Tarab animal life has proved no more productive. In the weeks following the research team's arrival on Tarab, Trevallis formulated chemical compounds based on his theories. In practice, these compounds produced only virus strains that either killed animal subjects outright or produced a host of horrible mutations.

While several of the experimental subjects have been kept alive for further study, additional research has not been promising. Subsequent experiments have produced only the contamination of Tarab's soil and water, as waste materials from the experiments are beginning to pollute the native environment.

This series of dismal, disappointing failures has sowed the seeds of both conflict and disillusionment among the Romulans. Even as the Klingon cadets were assembling on Satellite Outpost 2, numerous arguments among Trevallis' staff threatened to halt research completely. More and more of the Romulans are growing weary of failure as well as of Tarab's bleak surroundings.

NEW HOPE

The capture of Kyrstallia has changed the situation dramatically. Based on preliminary tests of her blood and tissue samples, Trevallis is now certain he has found the key that has evaded him for so long. At the moment the exercise team begins its descent to the planet's surface, Trevallis is preparing for one final series of experiments, to begin within 48 hours. Trevallis plans to use Kyrstallia to prove or disprove the validity of his theories once and for all. (In their enthusiasm over the promising results of Kyrstallia's test samples, the Romulans at first overlooked the computer tape she carries. They have so far only removed it for later examination and analysis.)



RACE AGAINST TIME

Once the player characters have determined that Kyrstal has been captured by the Romulans, they are in a race against time. Having located her, the cadets must rescue Kyrstal from the Romulans before Trevallis can begin subjecting her to his bizarre experiments.

Once rescued, Kyrstal will refuse to leave the Romulan compound until she has recovered her microtape, no matter what the risk to herself and her rescuers. This tape contains proofs of high-level Klingon involvement in the Triangle slave trade.

If the exercise team is not able to bring her back alive, then at least they must rescue Kyrstal's information. Only this will constitute a successful mission.

MISSION ACCOMPLISHED

With completion of their mission, the player characters will return to the *Excisor*, where a pleasant surprise awaits them. With the exception of Imperial Security, the ship's personnel will welcome the soon-to-be-midshipmen with a measure of respect the cadets have never before encountered (and likely will not encounter again.)

While they rest and recuperate during the journey back to Satellite Outpost 2, Commander Kameron (or his appointed successor) will prepare a formal evaluation of the group. He must report only those events that occurred on Tarab VI, evaluating the cadets according to strict guidelines. Depending on these individual performance ratings, the gamemaster may decide to bestow one or more honors for excellence in the service of the state.

GRADUATION NIGHT

Upon return to the Academy, the cadets take part in formal graduation ceremonies, which are traditionally conducted at night. Beneath the watching stars, the player characters will receive their Imperial commissions as midshipmen. In addition, each is presented insignia denoting his new rank and an officer's battle sash.

With their final test complete, the player characters can now prepare to meet the challenges of the upcoming, year-long cadet cruise. No longer will they be considered "wretched scum", but rather as officers in the service of the *Komerex*.

At the conclusion of the ceremonies, tradition holds that the Commandant of the Imperial Klingon Star Academy rise to salute each surviving member of the current year's graduating class with this toast: "Now, children, the game begins anew. To the *Komerex Zha* and all the players in it!"

Background Information

This information on the training given at the Imperial Klingon Star Academy is for use by the players, who are taking the roles of fourth-year cadets.

ACADEMY DAYS

"Nowhere else is the intensity of the Klingon way of life so manifest than at the service academies where tomorrow's conquerors are molded into whatever shape the ruling order dictates. It is here that the essence of everything good and evil in the Klingon psyche will be focused to a measure beyond belief."

*Korab vestai Huron
Director*

Imperial Security Training Operations Command

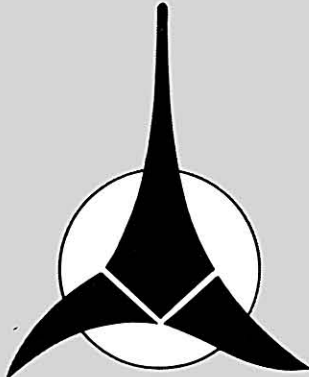

The Imperial Klingon Star Academy is the ultimate training ground for young men and women aspiring to become leaders of the Empire. The rigid discipline it imposes is intended to instill the highest possible degree of martial skills and loyalty to the state. The Academy also offers one of the most brutal experiences a member of Klingon society will ever endure. Not only is it a place of learning, but very often a place of torment where the strong very quickly make victims of the weak.

While some may question the methods employed, the fact is that the Imperial Klingon Star Academy achieves results. Graduates of the Academy are among the best-disciplined and most highly-motivated of all the starfaring races. Having conquered the rigors of the Imperial Klingon Star Academy, each graduate has good reason to believe he is fit to conquer the unknown dangers of space.

Cadets begin their training at the Star Academy at age twelve. Each trainee enters with the official designation "officer candidate". From the moment of arrival, however, cadets automatically become wards of the state, with all privileges of line honor or connection suspended for the duration of their stay. Any advantages a cadet may have enjoyed previously will not be restored until his graduation or dismissal. During their time at the Academy, each individual is undisputed state property.

THE FIRST YEAR

Once enrolled in the academy, cadets are organized into Academic Training Battalions (ATBs) under the command of a senior security officer (Thought Master) and various training officers known as Task Masters. Each ATB is further divided into Disciplinary Sections of 20 cadets, with a senior (fourth-year) cadet supervising the day-to-day activities of those in his section.

A Spartan Existence

First-year cadets begin life at the Academy with very little in their favor. Barracks life is spartan at best. Cadets are housed together, with no distinctions made for gender, racial type, or social origins. Food rations provide only the minimal daily nutritional requirements, unless a punishment is in effect. Uniforms are plain, without adornment or distinction.

A typical day in the life of an Academy cadet begins at 0300 every morning and continues non-stop for the next 18 hours, or until exhaustion sets in, whichever comes first. Such privileges as a cadet may enjoy at the Academy must be won anew every day. These include the privilege of drawing food rations, the privilege of medical attention following a training exercise, the privilege of study-time unmolested by senior classmates or duty officers and, occasionally, the privilege of uninterrupted sleep.

During the first months of life at the Academy, cadets quickly establish a well-defined pecking order based on superior strength and cunning within individual Discipline Sections. (This also determines who will be accorded privileges and who will not.)

Klingon Discipline

During their first day at the Academy, all cadets are routinely introduced (some for the very first time) to the dreaded agonizer booth. This "motivational device" (and the ever-present, palm-sized versions used by instructors and Task Masters) is a constant reminder of the Empire's domination over the individual well into adult life. To further underline this subservience, no cadet is ever permitted to speak during his or her first year unless first addressed by a senior officer or cadet. In response, the novice will address them as "My Lord".

Klingon discipline, often savage by human standards, is introduced as a practical matter of course during a cadet's first year. Severe penalties are inflicted on individuals for minor infractions or the failure to carry out assigned duties correctly. To offer "political inspiration", it is not unusual for entire sections (and even an entire battalion) to be punished for a single individual's failure to satisfactorily complete assigned tasks.

Because the Academy's administration is traditionally composed only of Imperial Klingons, cadets of Human- or Romulan-fusion are often subjected to racial harassment. There is no recourse against such prejudice but to endure.

During their first year at the Academy, cadets are exposed to a wide range of technical and military studies in which they are expected to excel. When not directly engaged in academic pursuits, the cadet will undergo

systematic physical conditioning aimed not at strengthening the individual but at breaking his endurance altogether. For example, a senior officer may punish a cadet for no other reason than to test his stamina. The test consists in seeing how long the individual can withstand intense pain before crying out, after which he will be punished for speaking out of turn.

Selecting The Best

Academy life during the first year is largely a deliberate weeding-out process. An estimated 40 per cent of the recently-arrived cadets will be quickly eliminated before the first year is up. Dismissal is usually due to a cadet's inability to complete the rigorous training exercises or to his being suspected of cowardice. In most cases, however, the cowards die first.

Imperial Security may deem an individual unsuitable for further training. Without warning or explanation, the cadet is immediately reassigned to the enlisted ranks. Many of these unfortunates eventually wind up in Klingon "Reserve Shock" battalions – frozen combat troops housed in hypothermia capsules from one year to the next. For this reason, officers often look upon the enlisted ranks as politically unreliable and racially inferior.



SECOND YEAR

In the cadet's second year at the Academy, academic studies receive greater emphasis, particularly in the sciences. Intense physical and political conditioning are also further stressed. During this stage of their development, cadets are deliberately exposed to inter-unit rivalries as a way of testing their loyalty and discipline.

Specialization

Senior officers begin to assign cadets to areas of responsibility, according to the current needs of the service. Those cadets earmarked for a branch such as Helm/Navigation, Weapons, or Communications begin their specialized training now. The individual cadet has no voice in deciding his service branch, and any overt objection to his assignment is grounds for immediate dismissal and reassignment. In any case, such objections are rare.

Should an individual demonstrate the kind of organizational skills need by administrators in the Empire's vast, interstellar bureaucracy, the cadet will be removed without warning. No social stigma is attached to the removal, as Klingons recognize the need for competent administrators and managers.

Privileges Granted

As a result of this selection process, a cadet may find himself unexpectedly reassigned. For example, would-be naval officers suddenly become slated for service as marines, and vice versa. In such cases, the individual is permitted to retain his/her given name rather than having to change it in conformance with tradition. Similarly, a cadet may appeal to retain a given name in honor of a particular family member even though the cadet is slated to serve in a branch where the name would not typically apply. In such cases, Academy officials will generally concede the point because they place more importance on the person's abilities than the label by which he or she is identified. (An example of this among known Klingon officers is that of Captain Kang's wife Mara. She serves in the role of Science Officer, though her given name would suggest a marine service designation.) The FASA rules supplement on *The Klingons* includes detailed information on Klingon name designations.

Those cadets who have survived their first year have also earned some meager advantages. Each may now address a fellow cadet (though not an officer as yet) without the need for prior permission. They are also receive limited recreational time so that social attachments can be made. A further mark of distinction is the bestowal of a (plain) battle sash.

THIRD YEAR

In their third year, cadets begin to put their training to the test. They undergo small unit combat training (under live battlefield conditions), planetary survival exercises in various simulated climates (unarmed and unaided), shipboard procedures (including simulated combat and emergency conditions), and unarmed combat drills (those judged 'killed' by their opponents forfeit their food ration for the day). By these drills, senior Task Masters seek to hone the skills most needed by a Klingon warrior, even if it costs a few lives in the process.

There is emphasis on political as well as military discipline. Each third-year cadet is subjected to numerous tests of political stability, including the Determinant Factor Exercise. In this exercise, the cadets in a particular Discipline Section are informed that their group has been evaluated as politically unreliable due to the actions of one among them, and that all are facing immediate expulsion. It now falls upon the members of the Section to determine the guilty party. Occasionally, a Section will manage to avoid punishment by rallying some special evidence of their collective loyalty. In other cases, cadets will band together, pledging each other's conduct with their own lives, thus saving themselves as a group. More often than not, however, the Determinant Factor Exercise results in one or more of a Section's members being singled out and offered up as scapegoats to an Imperial Tribunal.

As a reward for diligence and endurance, third-year cadets who have performed exceptionally to date are granted the privilege of limited off-duty time away from the Academy. Many use the time to visit their homeworlds, which most cadets are not likely see again until the end of their fourth and final year of training.

FOURTH YEAR

Much of the hardship each cadet must endure at the Academy has now come and gone. During their final year, cadets concentrate on sharpening skills. This is largely handled through additional branch training and whatever further study cadets select to fill in the gaps of their overall knowledge of things Klingon and beyond.

Of special importance, however, is the cadet's assumption of actual responsibility during these last few months. During this time, each senior cadet is placed in charge of a newly-formed Discipline Section (under the guidance and direction of a Task Master, with whom the cadet is allowed the privilege of free speech). The fourth-year cadet is responsible for the well-being of the younger cadets he now nominally commands. He is also responsible for the cadets' success or failure in performing assigned tasks. The senior cadet is evaluated by his superiors in this regard. In cases where senior cadets fail to sufficiently motivate their sections to acceptable levels of performance, the senior cadet is likely to be the one punished.

Final Exercise

The last months of a cadet's life at the Academy are spent in preparation for the final graduation exercise, which is conducted on a group basis. This Academy exercise should not be confused with the cadet cruise, which follows actual graduation. The graduation exercise tests each individual one last time to determine his suitability for the Imperial Klingon military.

The final exercise is, in fact, the cadet's first real duty assignment. Mission Plans for each graduation exercise are prepared by either Imperial Star Command, Naval Intelligence, or Security. Cadets are generally given tasks that require considerable effort to achieve, but that do not call for direct military presence. (Cadets are also considered more expendable than trained veterans, who may be needed elsewhere). During his cadet cruise, the newly-commissioned midshipman's performance is evaluated according to his ability to command.

MASTER OF CADETS KAMERON

Commander Kameron is a figure known and feared by both instructors and cadets alike at the Imperial Star Academy. Though a model officer with an excellent service record that includes several kill stripes to his credit, Kameron is also a rigorous Task Master who delights in setting unbelievably high goals both in and out of the classroom. Kameron further enjoys controlling every facet of a cadet's life.

First and foremost, Kameron seeks to instill obedience. He has a reputation for pushing his cadets to their limits, and beyond. More than one has broken under the pressure. It is also true that Kameron believes in leading by example. He would never demand anything of his charges before first demonstrating his own superior ability.

On a personal basis, Kameron makes little effort to hide his increasing dislike of his present post. Frustrated and angry, he often takes it out on the cadet sections in his charge, imposing extra duty, denying privileges, calling snap inspections, imposing unfair punishments. He avoids contact with fellow officers as much as possible, preferring to live among the Discipline Sections in his charge.

COMPUTER FILES

This material is contained in the Excisor's computer banks, and is available to the player characters en route to Tarab VI.

TARAB VI

World Log: Tarab VI

System Data

System Name:	Tarbus
Map Coordinates:	10.2S,5.6E
Number of Class M Present:	1

Planetary Data

Position In System:	VI
Number of Satellites:	3
Planetary Gravity:	1.1G
Planetary Size:	
Diameter:	14,700 km
Equatorial Circumference:	44,000 km
Total Surface Area:	585,000,000 sq km
Percent Land Mass:	87%
Total Land Mass:	508,950,000 sq km

Planetary Conditions:

Length of Day:	18 Hours
Atmospheric Density:	Thin
General Climate:	Glacial

Mineral Content:

Normal Metals:	5%
Radioactives:	Trace
Gemstones:	Trace
Industrial Crystals:	Trace
Special Minerals:	None

Cultural Data:

Dominant Life Form:	None
Technological/Sociological Index:	None
Planetary Trade Profile:	None

Brief History

Tarab VI is a frozen world in the midst of an ice age.

Only recently discovered and catalogued by a Klingon exploration team (who soon after perished on the planet's surface), Tarab was granted restricted military reserve status three years ago. Since that time, it has been used twice as a training ground for Academy cadets. The glacial climate cost the lives of both cadets and senior officers in each instance.

The close proximity of the planet's three natural satellites often results in sudden shifts in Tarab's magnetic field. This, in addition to the thin atmosphere, accounts for large amounts of radiation reaching the planet's surface at various times during the year. There has been little enthusiasm for converting Tarab into a forward-area outpost.

NATIVE LIFE-FORMS

Following are descriptions of native life-forms the player characters are likely to encounter on Tarab VI during Graduation Exercise. Earlier Klingon survey teams lacked sufficient time to properly catalogue native fauna, which is why the creatures are identified by their Romulan names. It is possible that other life-forms exist in regions of the planet not related to this adventure, and so this list cannot be considered exhaustive.

ALIEN CREATURE RECORD: N'ATOLLA

Life Form: Mammal
Size: Large
Feeding Habits: Carnivore

Average Attributes:

STR - 120
END - 100
DEX - 35
MENT - 05

Tactical Movement and Combat Statistics:

AP: 6
Combat Skill Rating: 50
Damage: 2D10+5
Armor: 7

General Description :

Averaging about 9 meters in length, these mammalian hunters resemble a large Terran serpent, except that they are covered with white fur instead of scales.

The N'Atolla are solitary by nature. Their typical method of attack is to remain motionless, camouflaged by natural surroundings. They wait until the last possible instant before springing unexpectedly on their prey. Though a N'Atolla can hold a victim in place through constriction, it prefers to swallow its prey whole. Strong digestive juices dissolve the victim in a matter of minutes. One of the Romulan security guards was killed by a N'Atolla before his comrades could rescue him.



ALIEN CREATURE RECORD: DARRONN

Life Form: Mammal
Size: Medium
Feeding Habits: Carnivore

Average Attributes:

STR - 35
END - 50
DEX - 70
MENT - 04

Tactical Movement and Combat Statistics:

AP: 8
Combat Skill Rating: 45
Damage: 1D10+7
Armor: 3

General Description

The Darronn is a medium-sized, leathery-winged mammal that lives in caves and other natural formations offering cover from the harsh Tarabian climate. Generally active in the early morning or late evening hours, it is a solitary hunter. The Darronn has a white, fur-covered body, and its piercing red eyes are set atop stalks coming from either side of the head. The creature propels itself not so much by actual flight as by gliding along the strong surface winds ravaging the surface of Tarab VI.

ALIEN CREATURE RECORD: T'ARKONNIC

Life Form: Mammal
Size: Small
Feeding Habits: Carnivore

Average Attributes:

STR - 35
END - 30
DEX - 70
MENT - 03

Tactical Movement and Combat Statistics:

AP: 9
Combat Skill Rating: 27
Damage: 1D10+2
Armor: None

General Description:

The T'Arkonn is a small, burrowing creature that vaguely resembles a Terran badger. They are pack animals who generally hunt in groups of up to ten at a time (roll 1D10 per encounter). The T'Arkonn recognize the presence of their prey by its body heat.

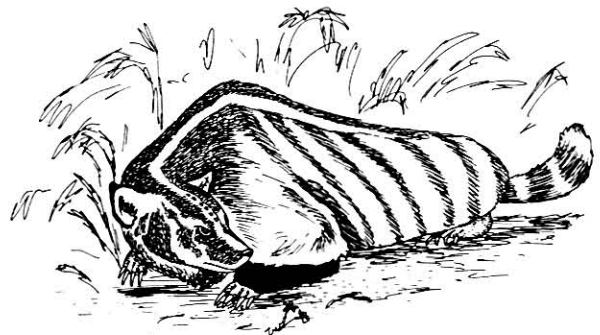

ALIEN CREATURE RECORD: ARBON

Life Form: Mammal
Size: Medium
Feeding Habits: Carnivore

Average Attributes:

STR - 55
END - 81
DEX - 55
MENT - 08

Tactical Movement and Combat Statistics:

AP: 9
Combat Skill Rating: 60
Damage: 1D10+9
Armor: 9

General Description:

Arbon are anthropoid creatures that walk on all fours. The dominant carnivore on Tarab VI, the Arbon is known as the "Golden One" because of its yellowish fur. The creatures have ravenous appetites, often attacking animals twice their size (and even one another) in an effort to maintain daily nutritional needs.



ALIEN CREATURE RECORD: WENNIC

Life Form: Mammal
Size: Large
Feeding Habits: Carnivore

Average Attributes:

STR - 95
END - 93
DEX - 85
MENT - 07

Combat Statistics:

AP: 7
Combat Skill Rating: 70
Damage: 2D10+7
Armor: 6

General Description:

Except for their long, shaggy white fur, these large, solitary hunters closely resemble Terran snow leopards. Wennic are natural enemies of the Arbon.

Computer Searches

The player characters may obtain the following information through computer searches made during the course of the adventure. Each entry is indexed by the key word(s) needed to access the file in the Klingon data banks. If player characters attempt to access information other than that presented here, the result of their investigations will be: "No Information Available At This Time".

Kameron, Cdr Kameron

All information regarding Commander Kameron sutai Rannic is priority-locked, as per Imperial Security Directive 479A-5, pending results filed from Security Investigation Team 479.

Orions, Pirates

Intelligence reports that several Orion vessels have approached the vicinity of the Tarab system in the last few months, although there is no direct evidence of Orion mercantile operations in this sector. The origin and nature of these contacts are unknown at this time.

Romulans

There are no intelligence reports of any Romulan military activity in or around the Tarbus system, although reports of Romulan military exercises in neighboring regions can be traced back over the last two years.

Tarab VI

The planet's standard day is 20 hours long. Several different types of mammalian life-forms were detected during the original planet survey, but information concerning their types and numbers is as yet largely speculative. Given the lack of sufficient winter vegetation, it is reasonable to assume that one or more carnivores may be present. There is also evidence of possible aquatic life in some of the warmer portions of the planet's oceans and inland lakes.

Analysis of the original survey data indicates that Tarab offers no commercial or military value, excluding its potential as a training area. However, training actions can be more easily conducted using facilities on already-established bases. Further exploitation of the planet is to be officially discouraged.

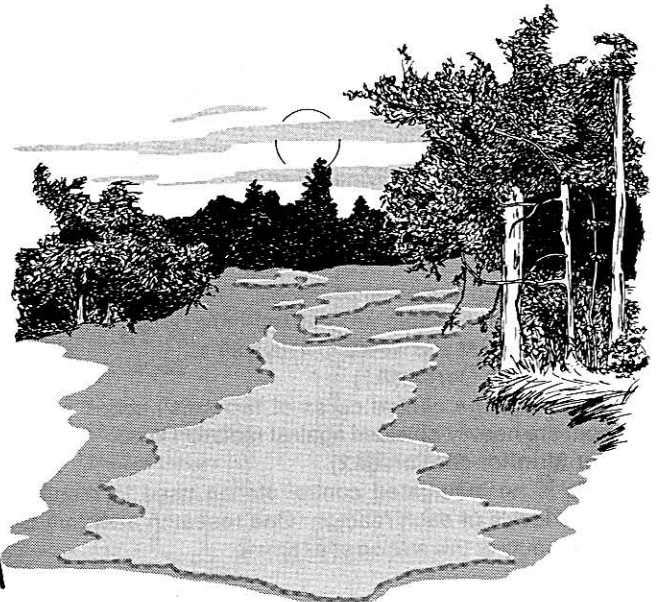

Maps

THE SEARCH AREA

The area of Tarab VI where the player characters will be operating is located in an area 20 kilometers in diameter along the equator. Dry, glacial conditions generally prevail in the region. Other than dried grasslands, there is vegetation resembling coniferous trees, but little else worthy of note. (See map of the search area.)

ROMULAN RESEARCH CENTER

The Romulan research center on Tarab VI is located in a large cave in the foothills of the mountain range near the equator. More than 150 meters long and over 30 meters high, it offers good protection from the Tarabian weather. It is also close to a local source of native life-forms, which Trevallis needs for his experiments. The outer areas of the cave are studded with numerous stalactites and stalagmites. A small underground stream runs the width of the cave, providing for easy disposal of chemical and animal wastes.

The entrance to the cave is guarded by a small force-field projector. Due to power constraints, this security device is activated only when actual experiments are in progress. There is a 49 percent chance that the force field will be activated when encountered by the player characters. Anyone making a successful Skill Roll against his current *Electronics* Skill Level will be able to detect the presence of the force field. Some 50 meters beyond the entrance, the player characters will encounter a deep crevice about three meters wide, over which a small bridge has been temporarily constructed. The main Romulan compound lies just beyond.

Trevallis has planted several explosive charges near the entrance to the cave. Should the center's presence be discovered by enemies and escape prove impossible, Trevallis will detonate these explosives. The resulting blast will bury him, his staff, any intruders, and all evidence of his experiments.

Within the Romulan compound itself are housed four single-story buildings, each constructed with prefabricated materials purchased from various off-world sources prior to the start of this adventure. These buildings include the Romulans' power plant, living quarters, research lab, and computer center. Each is briefly described below:

POWER PLANT:

This building supplies power for Trevallis' installation. Two small fusion reactors are housed here. They are used to power equipment and life-support systems.

Fusion Reactor Cores (A1)

These are the central cores of two small cobalt reactors. Both are heavily-shielded against radiation loss.

Reactor Monitor Station (A2)

This is an automated control station used to monitor the power levels of each reactor. One research assistant is typically on duty at this station at all times.

Storage Room (A3)

This room contains a large number of off-world medical and chemical support materials.

Radioactives Lab (A4)

This lab is used for preparation of the radioactive isotopes needed for Trevallis' experiments. One research assistant is on duty here during the day.

Reactor Ready Room (A5)

Stored here is protective gear worn by personnel whenever they are engaged in operations in or near the reactor room.

LIVING QUARTERS

This building provides accommodations for Trevallis and his staff while on Tarab VI. The Preserver Stone is also located here in Trevallis' quarters.

Personal Quarters/Security (B1)

These are the quarters for individual security guards. The personal effects of the two security guards killed prior to the start of this adventure have not as yet been collected for disposal or redistribution. These items include uniforms, weapons, personal mementos, and cold-weather gear.

Sanitary Facilities (B2)

These standard sanitary facilities are for use by all research center personnel.

Arms Locker (B3)

This small arms locker contains standard disruptor rifles and pistols.

Shrine (B4)

This enclosed shrine offers privacy for religious observances and meditation. There is a 20 percent chance that one of the center's personnel will be found here at any given time.

Trevallis' Quarters (B5)

In Trevallis' personal quarters are numerous documents and notes relating to his past experiments, as well as photographs from several different planets on which he has conducted prior experiments. Also to be found are numerous tapes containing detailed transcriptions of his progress to date. A terminal in this room connects Trevallis to the center's computer, and it is engaged at all times. Also present are several bottles of Saurian whiskey taken from Kyrstallia's camp. The Preserver Stone is also located here, protected by a small force field along one wall (similar to those used to house the subject animals in the pits).

Security Room (B6)

This security monitoring station is manned by one security guard at all times. From this room, the officer can make periodic scans of the interior of the cave and react to any emergency that may develop. There is a ten percent chance that an on-duty guard might detect one or more of the player characters on an interior monitor every five minutes that they are moving about the center. Kyrstallia's hand phaser and shathra will also be found here.

Storage Lockers (B7)

Food stores located here include Romulan ale as well as standard concentrates.

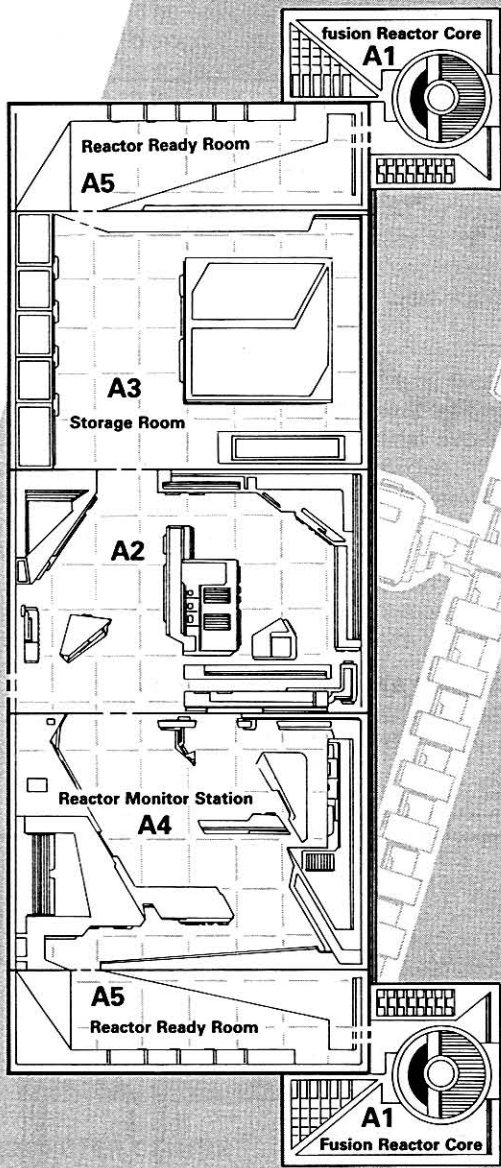

POWER PLANT

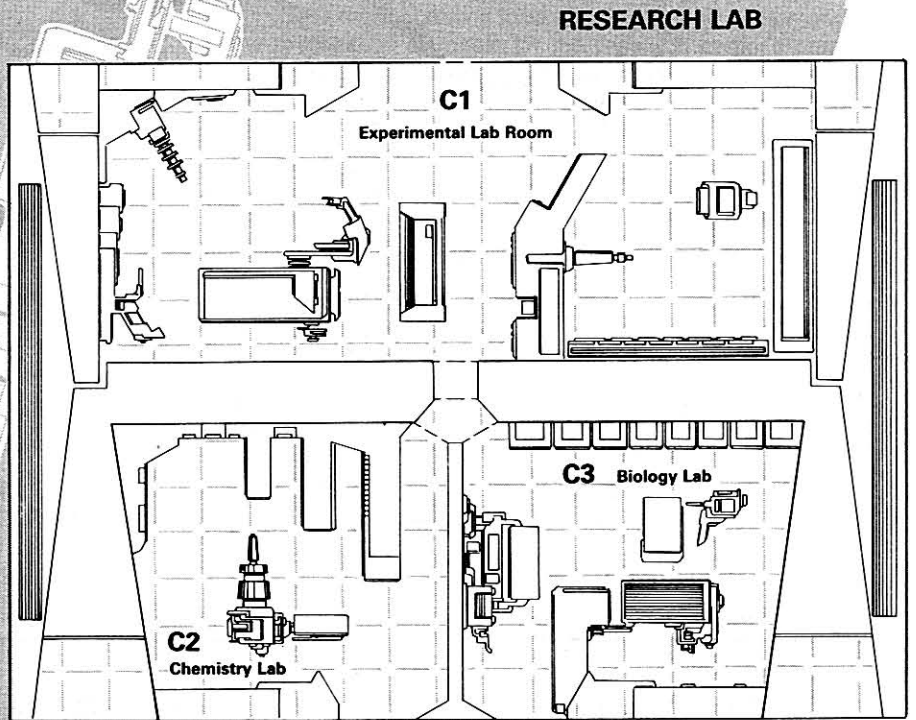

1 sq. = 1.5 meters

LIVING QUARTERS

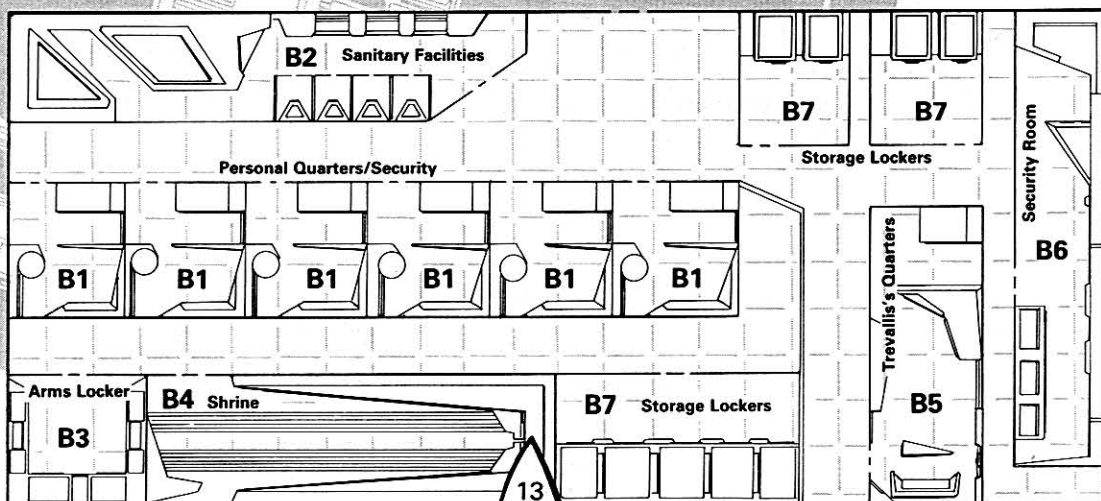

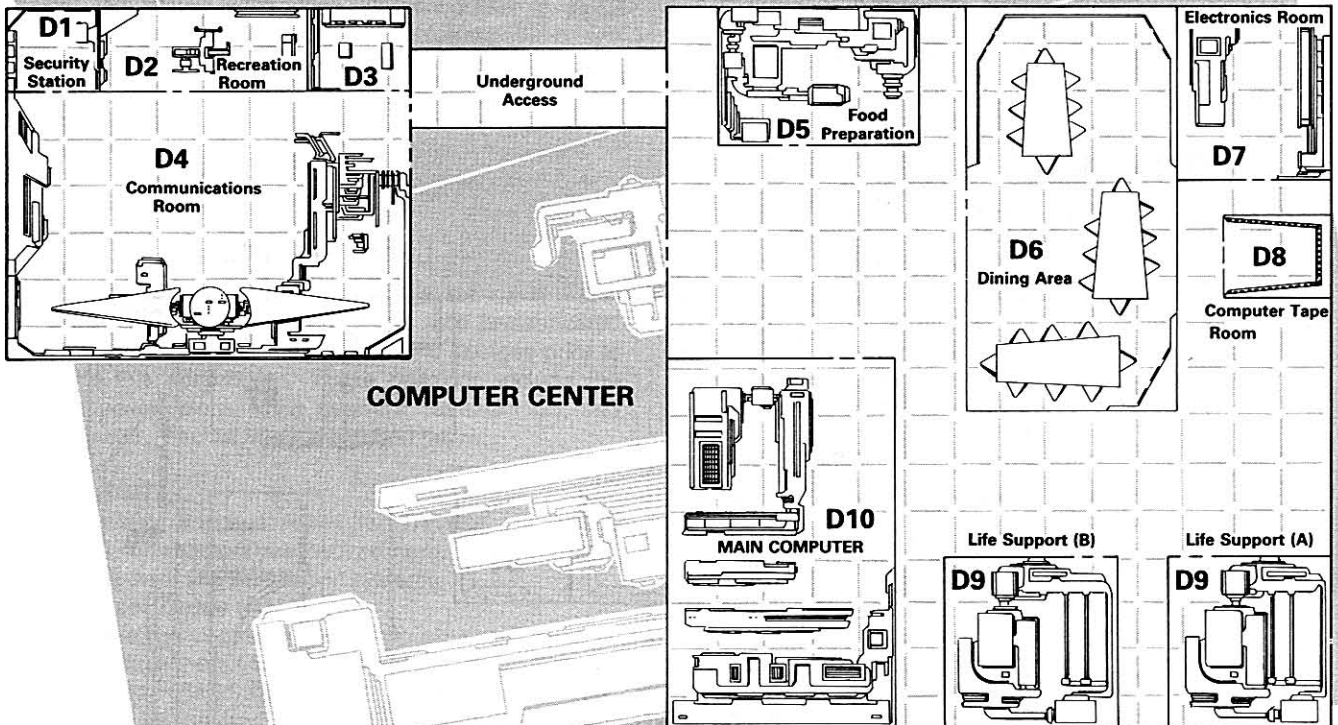
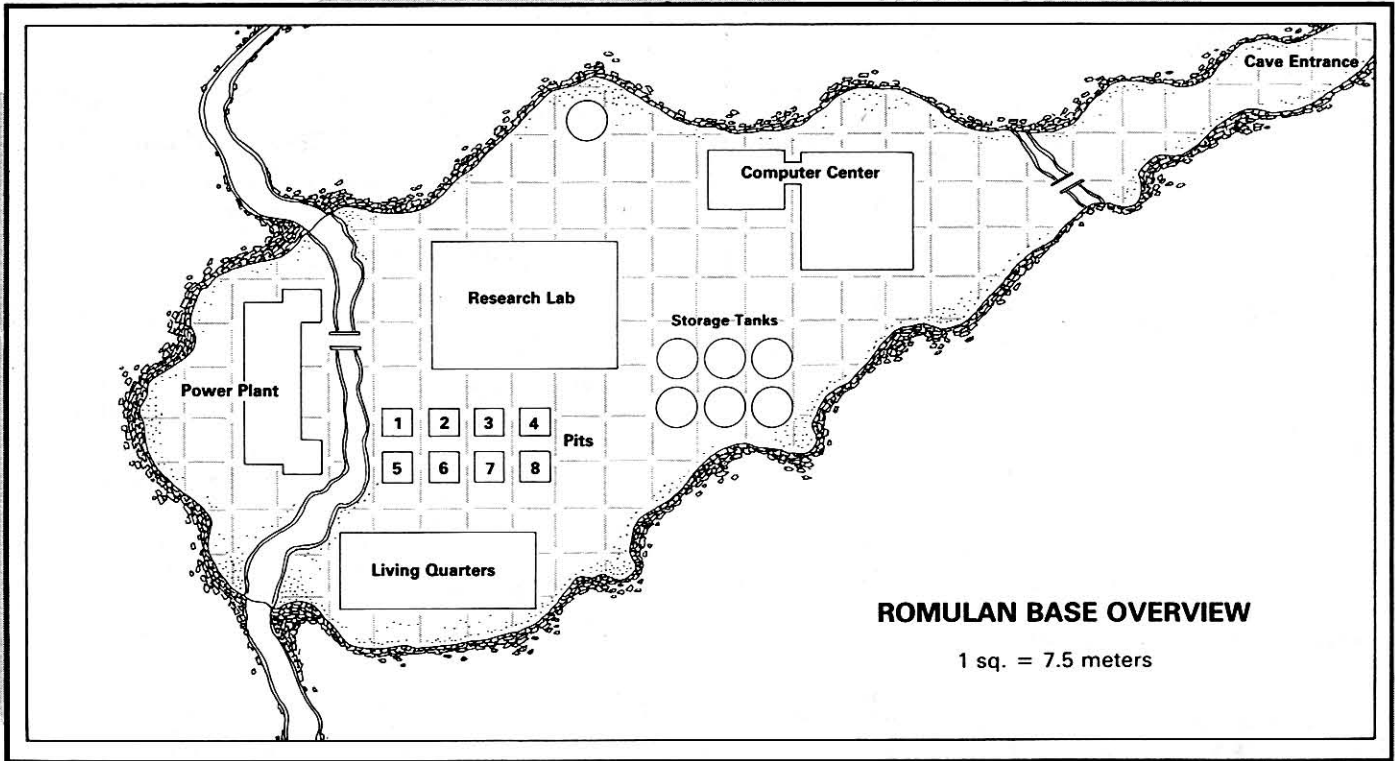

RESEARCH LAB

This building houses the equipment Trevallis needs to conduct his biological experiments. Animal subjects are transported here via small underground conveyors from the holding pits so that they can be examined and treated under germ-free conditions.

Lab Room (C1)

This room is the center for Trevallis' experiments on local animal subjects, and it is flanked by support machinery. A small scrub/preparation facility is off to one side. There is also a Wennic under sedation, being prepared by one of Trevallis' assistants for the next round of experiments.

Chemistry Lab (C2)

These are the biochemical research facilities used by Trevallis and his staff to produce viral strains capable of altering the genetic structure of animal subjects, with the aim of accelerating reproductive cycles. One research assistant will typically be on hand at all times, day or night, working or reviewing past results.

Biology Lab (C3)

This is the biology research support facility. It is used as a dissection room to conduct post-mortems on previous animal subjects. Various animal parts and organs will be preserved here for further investigation.



COMPUTER CENTER

This building holds Trevallis' research computer and numerous files detailing the extent of his work on the Preserver artifact from the time the research project began **Security Station (D1)**

This is an automated security station used as a back-up facility. There is also a locked cabinet in the the room, and it contains a master control switch for the detonation of the explosive charges buried near the entrance to the cave. This cabinet can be opened only by inserting and turning counter-clockwise the signet ring Trevallis wears on his right hand.

Recreation Room (D2)

This small recreation station contains video and audio tapes used by the center's personnel during their off-duty times. A bottle of Saurian whiskey will also be found among numerous personal effects belonging to the center's staff.

Library Room (D3)

This is Trevallis' private library, containing both micro-tape and book editions. While there are extensive materials on biology and chemistry, the library also includes one of the largest single collections of material pertaining to the Preservers.

Communications Room (D4)

The center's communications room contains a sub-space transmitter. It will be used to contact the Orion transport vessel to arrange for passage off Tarab VI at the conclusion of the research project. Kyrstallia's standard-issue Klingon communicator will also be found here, presently broken down for analysis.

Food Preparation (D5) Room

This room contains food dispensers and equipment for the preparation of meals for the research center's personnel. Several day's rations will be on hand. Kyrstallia's off-world food stores were looted from her camp and delivered here for future use.

Dining Area (D6)

This is the main dining facility for center personnel. It also doubles as a conference area. A terminal tied into the center's computer is also located here.

Electronics Room (D7)

Machinery and control systems for regulation of the research center's electronics equipment is housed here. Control of the center's force field units can be monitored from this location.

Tape Room (D8)

Stored here for use with the center's main computer are voluminous data on Trevallis' research, recorded on various types media.

Life Support (D9)

Housed here are the systems used to monitor and control various life-support functions throughout the center. This includes the maintenance of a germ-free atmosphere in the facility's research areas.

Main Computer (D10)

This central computer system is used to coordinate equipment function as well as to analyze the results of Trevallis' experiments. Kyrstallia's data tape is currently being held here for later examination.

PITS

A number of square pits have been dug in the floor of the cave compound to house the live animals used by Trevallis as experimental subjects. Each pit is roughly three meters square and of equal depth. These are guarded by small force fields (similar to the type used in shipboard detention areas) covering the pit openings. Currently housed in the pits are:

Pit 1:

A N'Atolla.

Pit 2:

Empty.

Pit 3:

An Arbonn.

Pit 4:

Agent Kyrstallia.

Pit 5:

A T'Arkonn.

Pit 6:

A dead Darronn.

Pit 7:

Empty.

Pit 8:

Empty.

Vessels

K-26 CLASS VII ESCORT

Construction Data:

Model Number —	Type A
Date Entering Service —	2/1710
Number Constructed —	12

Hull Data:

Superstructure Points —	11
Damage Chart —	B
Size	
Length —	97 m
Width —	100 m
Height —	24 m
Weight —	81,325 mt

Cargo

Cargo Units —	50 SCU
Cargo Capacity —	2500 mt
Landing Capability —	None

Equipment Data:

Control Computer Type —	ZD-6
Transporters —	
standard 6-person —	2
combat 20-person —	1
cargo, small —	1

Other Data:

Crew —	160
Troops —	12
Shuttlecraft —	1

Engines And Power Data:

Total Power Units Available —	39
Movement Point Ratio —	3/1
Warp Engine Type —	KWC-2
Number —	2
Power Units Available —	18
Stress Charts —	L10
Maximum Safe Cruising Speed —	Warp 8
Emergency Speed —	Warp 9

Impulse Engine Type —	
Power Units Available —	KIB-2

Weapons And Firing Data:

Beam Weapon Type —	KD-6
Number —	4
Firing Arcs —	f/p, f/s, a/p, a/s
Firing Chart —	T
Maximum Power —	6
Damage Modifiers —	
+2	(1 - 18)

Shields Data:

Deflector Shield Type —	KSF
Shield Point Ratio —	2/3
Maximum Shield Power —	10

Combat Efficiency:

D	56.9
WDF	20.4

EXCISOR

The *Excisor* is a 81,325 metric ton Klingon vessel of unusual experimental design not generally seen in large numbers far from the interior of the Empire. Because its radical shape has not proven noticeably effective, production of the class will likely be halted.

Though officially designated an escort, the vessel mounts firepower equal to that of an older *D-7* class light cruiser. Used primarily for courier and special-duty assignments, it is ideally suited for situations where the loss of a more advanced design would not be warranted.

CONDITIONS ABOARD SHIP

Morale aboard the *Excisor* is low because of the cramped living quarters and lack of sufficient recreational facilities, both of which can erode crew capabilities if continued over a lengthy period. Crew combat efficiency is currently rated as 56.

The majority of the officers aboard the *Excisor* are Imperial Klingons. Those few Klingon/Human fusions also serving aboard are typically treated as second-class individuals. Only the presence of Imperial Security has prevented the bigotry and harassment from creating serious problems. If the racial mix is evened out when ship's personnel is replaced and rotated upon return to Satellite Outpost 2, the situation could improve.

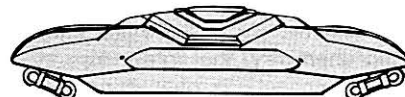
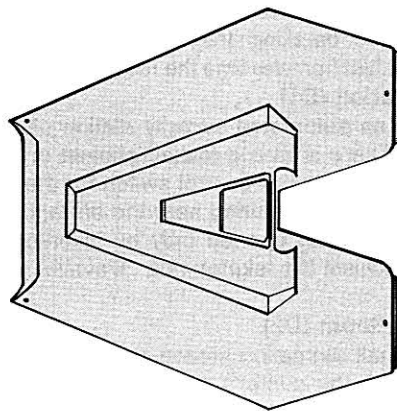
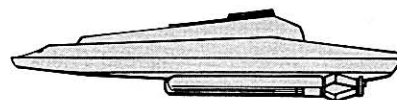

QUARTERMASTER SECTION

This section describes the equipment and other resources available to the players. The descriptions apply to items found both on Klingon Satellite Outpost 2 and the *IKV Excisor*. Those items available only on the satellite outpost are denoted by an asterisk(*).

Player characters should be required to discover these items for themselves either prior to leaving the outpost or aboard ship. Players can refer to FASA's *The Klingons* supplement for more detailed descriptions of many of the items given below.

COLD-WEATHER CLOTHING

This is standard-issue, arctic-climate gear adapted to Klingon physiology. The gear includes boots, parkas, gloves, and other protection for exposed areas.

COMMUNICATORS

These are standard-issue Klingon communicators.

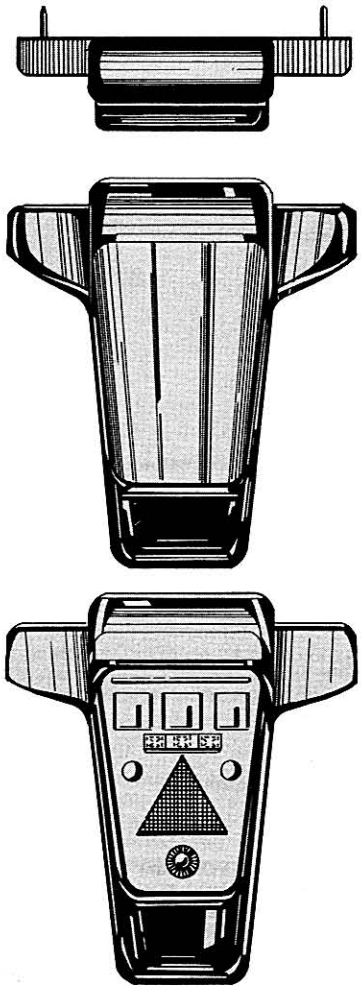

ENVIRONMENTAL SUITS

These standard-issue space suits are capable of providing a self-contained environment for up to 24 hours.

DISRUPTOR WEAPONS

There are Mark I pistols and rifles available aboard the *Excisor*. Mark II weapons are available only on Satellite Outpost 2.

PERSONAL COMBAT BLADE

This large, tri-bladed weapon is a favorite of Klingon ground troops.

PLANETARY SURVIVAL KIT

An emergency planetary survival pack is issued aboard ship to each player character. It contains the following: one small saw-toothed knife, emergency rations in concentrate form adequate for up to 72 hours, a pain-blocker capsule, a packet of magnesium heat capsules, three chemical light tubes, and about one-third liter of water.

*TRICORDER

The tricorder is a standard-issue sensor and recording device.

*VEGAN TOBACCO

This luxury blend of tobacco is imported from across the Triangle zone.

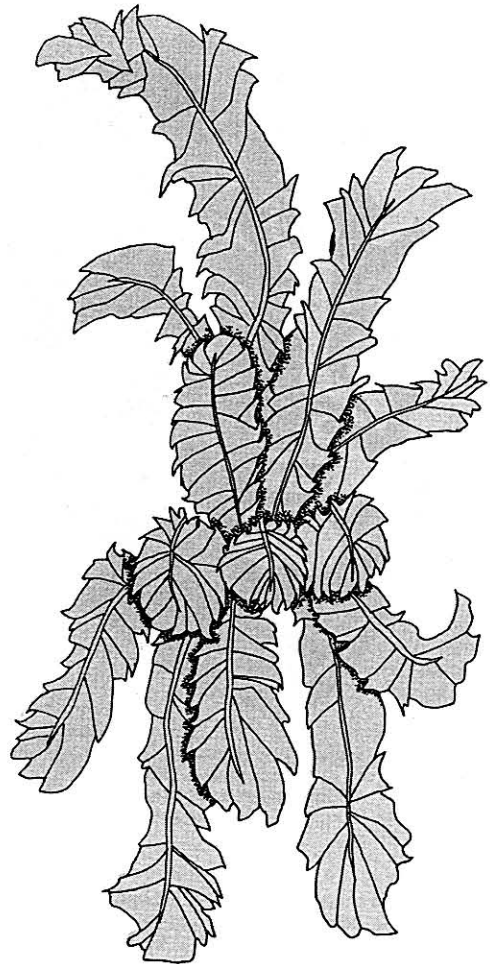

Cast Of Characters

Character Data Record Sheets for six pre-generated player characters are provided in this chapter. Players may use these characters or replace them with equivalent characters of their own, subject to the gamemaster's approval. Statistics for major and minor NPCs are also included, intended solely for the gamemaster's use.

Those wishing to substitute characters designed 'from scratch' should follow the character-generation procedures outlined in *The Klingons* supplement. Note that at the start of this adventure, every player character is 16 years of age.

While players may make substitutions without harming the integrity of the adventure, the gamemaster will have to construct background material on personal relationships for each new character (requiring additional preparation time before the adventure can begin.)



CADET EXERCISE GROUP 473

Name: KALLA ROVASHI

Rank/Title: Cadet

Current Assignment: Imperial Klingon Star Academy, Academic Training Battalion 416, Alpha Discipline Section 118

Position: Officer Candidate

Race: Imperial Klingon

Age: 16

Sex: Female

Attributes:

STR - 48	CHA - 46
END - 50	LUC - 37
INT - 55	PSI - 02
DEX - 65	

Combat Statistics:

To-Hit Numbers -	Bare-Hand Damage: 1D10 + 3
Modern: 46	AP: 10
HTH: 48	

Significant Skills

	Rating
Administration	10
Artistic Expression, Acrobatics	15
Astronomy/Astrophysics	10
Bribery	12
Carousing	10
Communications Technology	20
Computer Operations	24
Computer Technology	26
Electronics	25
Environmental Suit Operations	10
Gaming	16
Instruction	20
Interrogation	10
Language	
Galacta	18
Romulan	20
Leadership	30
Marksmanship, Modern Weapon	27
Medical Science	
General Medicine, Klingon	17
Klingon Psychology	10
Personal Combat	
Knife	20
Unarmed	32
Physical Sciences	
Biology	10
Chemistry	22
Computer Science	18
Mathematics	15
Planetary Survival	32
Social Sciences	
Klingon History	17
Starship Helm Operations	
25	
Trivia, Poisons	12

Distinguishing Physical Characteristics:

None.

Brief Personal History:

Birthplace: Morab VII, Gamma Quadrant

Kalla comes from an Imperial family that has fallen on bad times. Most of her closest relatives have been either lost in combat or are otherwise missing, including her own parents. Kalla's acceptance into the Academy was largely the result of efforts by her uncle, Kameric sutai Rovashi, who served competently, if not spectacularly, at court for many years. A high-achiever, Kalla sees eventual success in the service as a means of regaining her family line's lost status.

Personality:

Motivations/Desires/Goals

Kalla's greatest desire is to accomplish a feat worthy of Imperial notice in order to revitalize the prestige of the Rovashi. She would also like to make the kind of marriage that would help her rise through the ranks in the least amount of time.

Manner:

Kalla is soft-spoken. Whenever possible, she prefers to listen rather than voice her own opinions. She can be quite cold-blooded if sufficiently provoked.

Name: KIRLACK 'ILLIOTH**Rank/Title:** Cadet**Current Assignment:** Imperial Klingon Star Academy,
Academic Training Battalion 416 Alpha, Discipline Section 118**Position:** Officer Candidate**Race:** Imperial Klingon**Age:** 16**Sex:** Male**Attributes:**

STR - 59	CHA - 37
END - 70	LUC - 28
INT - 55	PSI - 04
DEX - 82	

Combat Statistics:

To-Hit Numbers-

Modern: 55
HTH: 58

Bare-Hand Damage: 1D10 + 6
AP: 12

Significant Skills

	Rating
Administration	10
Astronomy/Astrophysics	22
Bribery	23
Carousing	29
Computer Operations	32
Environmental Suit Operations	10
Gaming	17
Language	
Galacta	23
Orion	20
Leadership	33
Instruction	17
Interrogation	20
Marksmanship	
Archaic Weapons	25
Modern Weapons	28
Personal Combat	
Pistol	27
Unarmed	34
Physical Sciences, Computer Science	11
Geology	25
Planetary Survival	38
Social Sciences, Klingon History	15
Small Unit Tactics	12
Starship Helm Operations	28
Starship Navigation	27
Starship Security Procedures	20
Transporter Operations	25
Transporter Technology	10
Trivia, Native Klingon Predators	13

Distinguishing Physical Characteristics:

Kirlack has a large scar above his right eye, the mark of an instructor's whip.

Brief Personal History:**Birthplace:** Klinzhai

Kirlack comes from one of Klinzhai's oldest and most influential family lines, a fact he attempts to use to his advantage at all times. He is following a long-established family tradition of service to the Empire in the Imperial Navy. Unfortunately, he ran afoul of Commander Kameron in the past when attempting to use his family's influence to secure preferential treatment. Except for that unsuccessful ploy, Kirlack's record is clean.

Personality:**Motivations/Desires/Goals:**

With his Imperial Klingon background, Kirlack has nothing but contempt for fusion races, which he considers inferior sub-species. He likes nothing better than to prove his intrinsic superiority by accomplishing something a Fusion cadet has previously tried and failed. Kirlack hopes to distinguish himself so highly during the graduation exercise that he will be posted to the Navy for his midshipman cruise.

Manner:

Kirlack is arrogant to the extreme, a self-proclaimed expert in various skill areas. As might be expected, his manner is brash, occasionally bold. He is also quick-tempered and vindictive.

Name: KURON TRETH**Rank/Title:** Cadet**Current Assignment:** Imperial Klingon Star Academy,
Academic Training Battalion 416 Alpha, Discipline Section 118**Position:** Officer Candidate**Race:** Klingon/Human Fusion**Age:** 16**Sex:** Male**Attributes:**

STR - 48	CHA - 59
END - 56	LUC - 58
INT - 76	PSI - 06
DEX - 46	

Combat Statistics:

To-Hit Numbers -

Modern: 39
HTH: 37

Bare-Hand Damage: 1D10 + 2

AP: 8

Significant Skills

	Rating
Administration	10
Astronomy/Astrophysics	20
Bribery	32
Carousing	24
Computer Operations	30
Electronics Technology	22
Environmental Suit Operations	10
Gaming	11
Interrogation	27
Instruction	28
Language	
Galacta	30
Tellarite	15
Romulan	23
Leadership	20
Marksmanship, Modern	32
Personal Combat	
Spear	27
Unarmed	28
Physical Sciences	
Computer Science	15
Mathematics	18
Social Sciences	
Klingon History	10
Klingon Law	15
Shuttlecraft, Piloting	22
Small Unit Tactics	10
Starship Deflector Shield Technology	15
Starship Helm Operations	20
Starship Strategy and Tactics	15
Starship Warp Drive Technology	10
Starship Weaponry	25
Transporter Operations	20
Transporter Technology	12
Trivia	
Romulan Technology	18
Triangle Cultures	26
Triangle History	22

Distinguishing Physical Characteristics:

Kuron is missing one finger.

Brief Personal History:**Birthplace:** Pletarc Colony, Kazrak

Kuron has lived most of his short life on his family's holdings on Pletarc, a small administrative post in the Triangle where his father has served as a minor administrative official for some time. His family considers Kuron's admission to the Academy a means of gaining the social recognition and acceptance so long denied them. Because of his Fusion origins, Kuron has encountered considerable prejudice from Academy instructors, especially Commander Kameron. In one instance, Kameron refused to allow the cadet proper medical attention following a training accident. The young man eventually lost a finger because of the untreated infection. Despite this, Kuron has so far maintained a creditable service record.

Personality:**Motivations/Desires/Goals**

Kuron desperately seeks to excel in his graduation exercise in order to disprove the intense racial prejudice he has encountered. Success will also bring honor to his family line, one of the prime goals of his life. Because of the unfair treatment he has suffered, Kuron has little respect for Imperial Klingons in general and Kameron in particular. However, his loyalty to the Komerex is unswerving.

Manner:

Kuron is generous to a fault, perhaps because he so desperately desires acceptance by his peers.

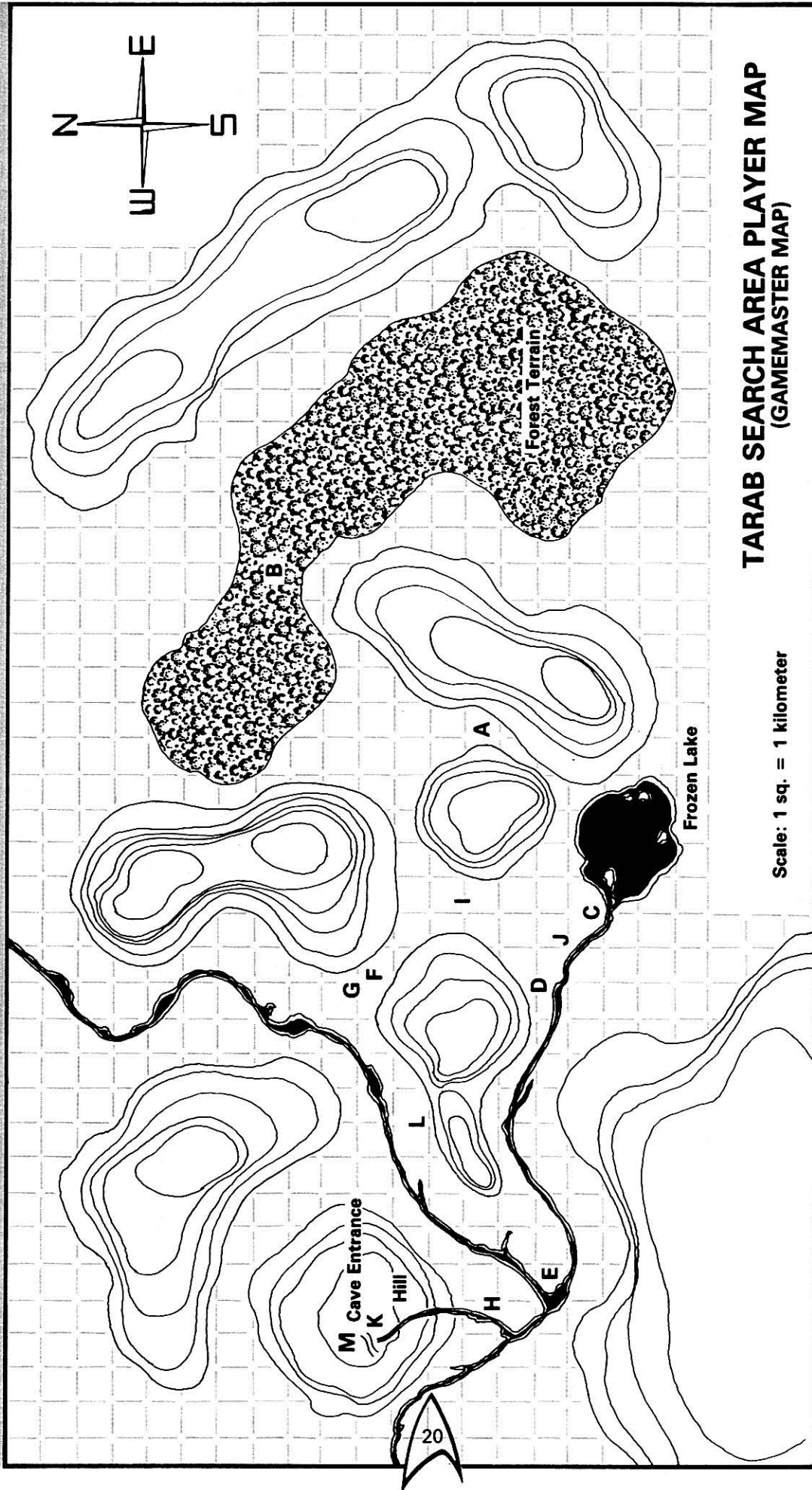

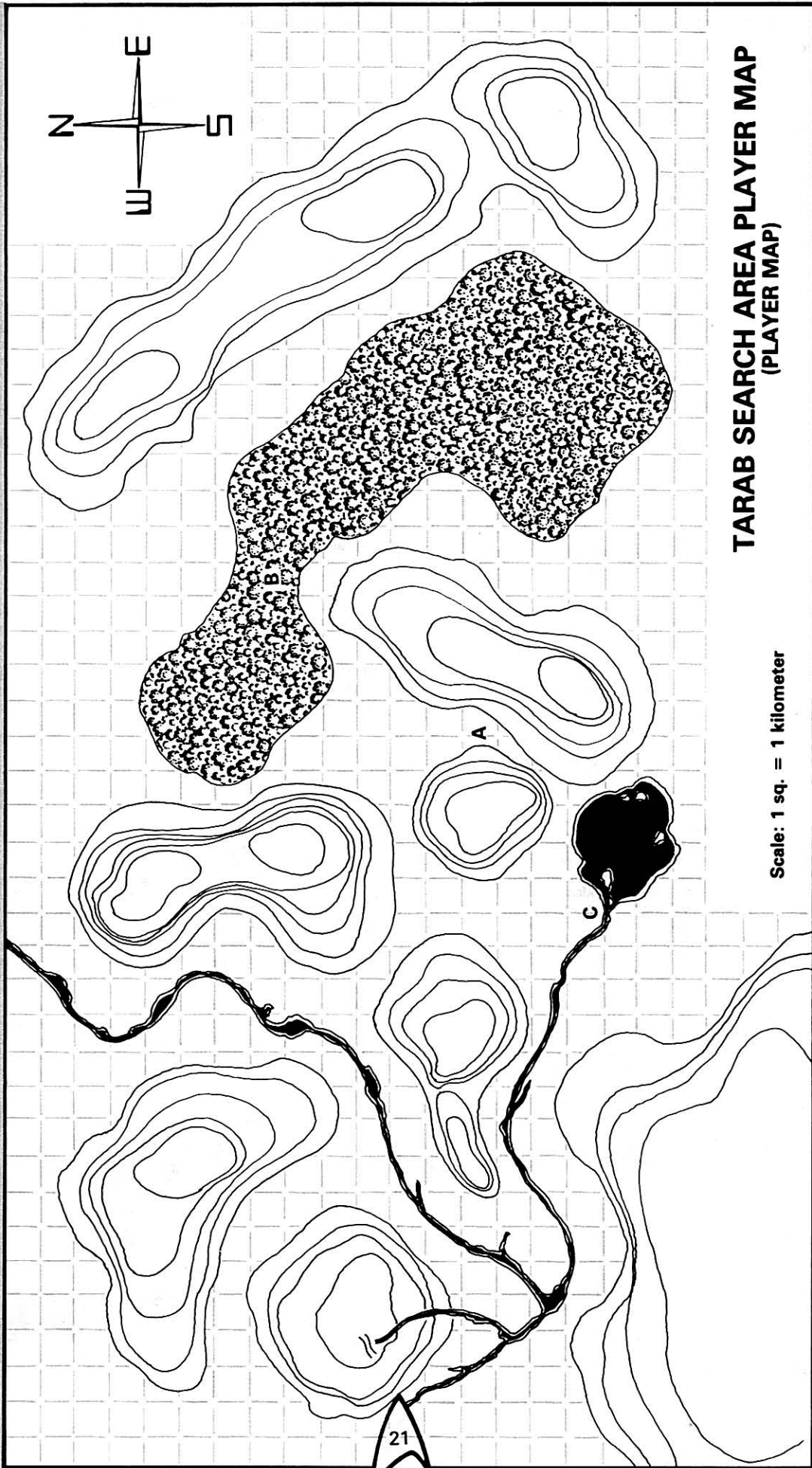

TARAB SEARCH AREA PLAYER MAP
(PLAYER MAP)

Scale: 1 sq. = 1 kilometer

Name: MAZRAC HURN

Rank/Title: Cadet
Current Assignment: Imperial Klingon Star Academy,
Academic Training Battalion 416 Alpha, Discipline Section 121
Position: Officer Candidate
Race: Klingon/Human Fusion
Age: 16
Sex: Male

Attributes:
STR - 48 CHA - 32
END - 56 LUC - 27
INT - 57 PSI - 03
DEX - 66

Combat Statistics:
To-Hit Numbers - Bare-Hand Damage: 1D10 + 4
 Modern: 52 AP: 10
 HTH: 53

Significant Skills	Rating
Administration	10
Astronomy/Astrophysics	10
Carousing	44
Computer Operations	12
Environmental Suit Operations	10
Gaming	47
Ground Vehicle Operations	28
Interrogation	20
Instruction	10
Language,	
Galacta	33
Orion	27
Leadership	22
Marksmanship, Modern	38
Mechanical Engineering	25
Personal Combat	
Knife	40
Unarmed	40
Planetary Survival	40
Streetwise	38
Transporter Operations	10

Distinguishing Physical Characteristics:
Mazrak suffered massive hair loss from radiation exposure during a previous training exercise.

Brief Personal History:
Birthplace: Korvaline, Beta Quadrant
Mazrak spent his time in a different Academy Training Base than the cadets described above. He and Mijarn are close friends. A year ago, Mijarn saved Mazrak's life when a training simulator became flooded with hard radiation during a training mishap. Despite this accident, Mazrak's record has been satisfactory. Though not an exceptional cadet, Mazrak is better than average. His clear thinking and quick-reaction time are well known within his own battalion. Mazrak has the makings of a good officer if he is given the kind of independent commands that would allow him to grow and develop.

Personality:
Motivations/Desires/Goals:
Though he has no proof to support his allegations, Mazrak secretly holds commander Kameron responsible for the training accident that nearly cost him his life. Mazrak believes Kameron deliberately staged the accident. (Kameron was angry after he had challenged Mazrak to a compulsory *Klin zha* match, which the cadet made the mistake of winning handsomely.) Mazrak would like nothing better than to repay the debt one day. Unofficially, of course.
Manner:
Mazrak behaves in an extremely cool, unfeeling manner. Since his accident, he generally associates only with the very few cadets he considers his friends.

Name: MEDAN LINZOR

Rank/Title: Cadet
Current Assignment: Imperial Klingon Star Academy,
Academic Training Battalion 416 Alpha, Discipline Section 118
Position: Officer Candidate
Race: Imperial Klingon
Age: 16
Sex: Male

Attributes:
STR - 58 CHA - 27
END - 48 LUC - 32
INT - 63 PSI - 03
DEX - 70

Combat Statistics:
To-Hit Numbers - Bare-Hand Damage: 1D10 + 6
 Modern: 52 AP: 11
 HTH: 54

Significant Skills	Rating
Administration	10
Astronomy/Astrophysics	20
Carousing	25
Computer Operations	20
Electronics Technology	22
Language	
Galacta	30
Orion	27
Interrogation	12
Leadership	28
Marksmanship, Modern	34
Medical Science,	
General Klingon Medicine	30
Klingon Psychology	20
Personal Combat	
Dagger	34
Unarmed	38
Security Procedures	10
Small Unit Tactics	26
Social Sciences	
Klingon History	12
Klingon Law	20
Transporter Operations	10
Trivia, Klingon Recreation Centers	30

Distinguishing Physical Characteristics:
None.

Brief Personal History:
Birthplace: Support Colony 145, K'Kaarr
Medan comes from a minor family line of no particular influence. When he entered the Academy, it was in the hope of becoming a naval officer. However, he was selected for service as a marine graduate on the recommendation of Master of Cadets Kameron. During the last few years, he has received special marine training. Medan has resented this frustration of his hopes, but has performed at an acceptable level nonetheless.

Personality:
Motivations/Desires/Goals
Medan would like nothing better than to prove that Commander Kameron was wrong in posting him to marine service.
Manner:
With his open and pleasant manner, Medan is rare among Klingons.



Name: MIJARN KOMMORA

Rank/Title: Cadet
Current Assignment: Imperial Klingon Star Academy,
Academic Training Battalion 416 Alpha, Discipline Section 121
Position: Officer Candidate

Race: Klingon/Romulan Fusion
Age: 16
Sex: Male

Attributes:
STR - 65 CHA - 42
END - 68 LUC - 37
INT - 73 PSI - 25
END - 56

Combat Statistics:
To-Hit Numbers - Bare-Hand Damage: 1D10 + 7
Modern: 48 AP: 9
HTH: 50

Significant Skills	Rating
Administration	10
Astronomy/Astrophysics	15
Bribery	39
Carousing	12
Computer Operations	22
Computer Technology	35
Electronics Technology	27
Interrogation	20
Language	
Galacta	32
Romulan	38
Leadership	42
Marksmanship, Modern	40
Personal Combat	
Dagger	37
Unarmed	44
Security Procedures	20
Shuttlecraft Piloting	27
Small Systems Technology	12
Social Sciences, Klingon History	30
Trivia, Romulan Culture	30

Distinguishing Physical Characteristics:
Mijarn is missing the last finger on his left hand, the result of a punishment inflicted by Commander Kameron.

Brief Personal History:
Birthplace: Unknown.
Because of his racial background, Mijarn has experienced racial bigotry from many of his instructors. Despite this harassment, he has demonstrated excellent abilities in many technical areas. During a previous training exercise, a fellow member of Mijarn's cadet section was almost killed. Mijarn showed bravery in rescuing the cadet, whose life was saved. Kameron later attempted to shift blame for the incident on Mijarn, and a subsequent punishment left the cadet seriously injured for some time.

Personality:
Motivations/Desires/Goals:
Though slated for eventual service with ground troops, Mijarn hopes to acquire a technical or support duty that will permit him to fully utilize his technical skills. Mijarn dislikes Kameron immensely, but is deeply committed to the discipline of the service.

Manner:
Mijarn is reserved and aloof.



MAJOR NPCs

Name: KAMERON SUTAI RANNIC

Rank/Title: Commander
Current Assignment: Imperial Klingon Star Academy
Position: Instructor, Master of Cadets,
Cadet Evaluator for Exercise Group 473

Race: Imperial Klingon
Age: 38
Sex: Male

Attributes:
STR - 76 CHA - 56
END - 70 LUC - 37
INT - 74 PSI - 07
DEX - 76

Combat Statistics:
To-Hit Numbers - Bare-Hand Damage: 2D10 + 4
Modern: 64 AP: 11
HTH: 62

Significant Skills	Rating
Administration	35
Artistic Expression, Sculpting	22
Astronomy/Astrophysics	25
Computer Operations	48
Computer Technology	37
Environmental Suit Operations	12
Gaming	27
Instruction	48
Interrogation	44
Language	
Galacta	37
Orion	28
Caitian	12
Leadership	49
Marksmanship, Modern	52
Mechanical Engineering	22
Personal Combat	
Knife	38
Unarmed	48
Personal Weapons Technology	15
Planetary Survival	35
Starship Deflector Shield Technology	30
Starship Helm Operations	30
Starship Navigation	28
Starship Security Procedures	20
Starship Sensors	25
Starship Weaponry Technology	25
Trivia	
Orion Culture	44
Orion Law	47

Distinguishing Physical Characteristics:
As a young lieutenant, Kameron lost his left eye as the result of a dueling incident.

Brief Personal History:
Birthplace: Kelvannin Colony, Alpha Quadrant
Kameron is a line officer suspected of being actively involved in illegal slave trading through intermediaries in the Triangle. For that reason, his bid for captaincy has so far been unsuccessful. While the accusations brought against Kameron have always been dismissed for lack of evidence, he was transferred to the Academy as an instructor at the close of his last deep space assignment. Imperial Security hopes to keep a closer watch on him in hopes of eventually substantiating the charges. Despite it all, Kameron has earned the fear, if not the admiration, of many fellow officers in the fleet.

Personality:
Motivations/Desires/Goals:
Kameron views his present assignment as nothing less than a well-disguised disciplinary action by members of Imperial Security, who intend to curb his growing influence. Kameron will do anything to be promoted to a line command once again. At this stage in his career, his only hope is that his exercise group will achieve superior honors in their final testing on Tarab. Unless he meets with some unexpected bit of good fortune, he is likely to remain at the mercy of Imperial Security.

Manner:
Kameron is cold and calculating. He is also given to periods of deep depression during which he takes out his frustrations on cadets under his charge.

Name: KYRSTAL STALLAMAINE

Rank/Title: Free Agent
Occupation: Intelligence-Operative, Triangle Zone

Race: Orion/Human Fusion
Age: 28
Sex: Female

Attributes:

STR - 49	CHA - 75
END - 58	LUC - 77
INT - 82	PSI - 12
DEX - 74	

Combat Statistics:

To-Hit Numbers - Modern: 72 HTH: 54	Bare-Hand Damage: 1D10 + 2 AP: 11
---	--------------------------------------

Significant Skills	Rating
Administration	12
Bribery	45
Carousing	22
Computer Operations	56
Forgery	42
Language	
Galacta	57
Orion	55
Klingon	48
Romulan	37
Leadership	28
Marksmanship, Modern	70
Negotiation/Diplomacy	15
Personal Combat	
Orion Shathra	40
Unarmed	28
Planetary Survival	20
Trade And Commerce	30
Small Vessel Piloting	20
Social Sciences	
Federation Law	46
Klingon Law	33
Romulan Law	28
Transporter Operations Procedures	10
Trivia	
Orion Culture	57
Triangle Slave Trade	56
Value Estimation	49

Distinguishing Physical Characteristics:
 Despite the charismatic abilities inherited from her Orion father, Kyrstal lacks the biological charms of a typical Orion woman. Nevertheless, her long, copper-colored hair and tall, slender build make Kyrstal Stallamaine quite a striking figure. Although she is of a dusky Orion complexion, she can generally pass for Human.

Brief Personal History:
Birthplace: Santara, Precipice
 Kyrstal is the daughter of a wealthy Orion merchant. While en route to Fountainworld in the Triangle Zone, her parents were killed and she captured by Klingon privateers. The girl was later sold by Orion traders to the Bio-Research Corporation on Comstock. They trained her to be an intelligence agent, but Kyrstal afterwards dissassociated herself from BioResearch when she learned of the firm's involvement with planned assassinations. Having gained control of her parent's vast inheritance, Kyrstal has made the best of an otherwise bad situation. She is using her newly-acquired skills as a freelance operative, and will work anywhere, for any side, for the right price.

Personality:
Motivations/Desires/Goals:
 Given her previous experiences, Kyrstallia (the Orion version of her name adopted in honor of her father) has little love for the Klingon Empire. However, she will work with them against the Orions (and vice versa) as need be. Business aside, Kyrstallia hopes one day to play a major role in eliminating illegal slave trade in the Triangle once and for all.
Manner:
 Kyrstallia is fiercely loyal toward friends and equally ruthless toward enemies. Although her manner is generally reserved, she can display a ruthless nature toward friend and foe alike when roused to action.

Special Knowledge/Powers:
 Kyrstallia has collected voluminous proofs of slaver activities in the Triangle zone, which she keeps in a special computer file. Should it be made public, this tape is likely to implicate Kameron as well as numerous important Klingons and Orions. Kyrstallia carries this microtape file on her person at all times.

Name: TREVALLIS

Rank/Title: Civilian (Ex-Centurion, Exploration Division)
Position: Research Scientist

Race: Romulan
Age: 37
Sex: Male

Attributes:

STR - 37	CHA - 42
END - 28	LUC - 27
INT - 67	PSI - 04
DEX - 38	

Combat Statistics:

To-Hit Numbers - Modern: 38 HTH: 30	Bare-Hand Damage: 1D10 + 2 AP: 7
---	-------------------------------------

Significant Skills	Rating
Administration	20
Computer Operations	15
Language, Galacta	40
Marksmanship, Modern	38
Negotiation/Diplomacy	57
Personal Combat	
Pistol	30
Unarmed	22
Physical Sciences	
Biology	64
Chemistry	05
Geology	14
Zoology	34
Starship Security Procedures	30
Trivia, Preserver Culture	44

Distinguishing Physical Characteristics:
 Trevallis' skin is pallid and covered with numerous chemical burns and other scars. His appearance is extremely frail due to his failing health.

Brief Personal History:
Birthplace: Uzar'ak Military Outpost 4
 As a member of the Romulan exploration division, Trevallis operated along the edge of the Federation border as a science officer on a small scout ship. Six years ago, he uncovered the remains of a Preserver site on a previously-unexplored planet. On this site, he also found a small stone obelisk inscribed with unknown symbols. Convinced that the inscriptions were actually chemical formulas offering the promise of new technology, Trevallis obtained permission to head a research team to decipher the stone's markings. This project ended in dismal failure when a plague virus resulting from Trevallis' experiments was accidentally released. The virus wiped out half the local population.

Although Trevallis was soon after stripped of his rank, he was able to find private funding to continue his experiments (on the condition the research be conducted in the Triangle Zone.) Trevallis has been carrying out a race against time ever since. Although he survived the initial disaster that ended his military career, the ex-centurion is now dying from the same fatal virus. At the start of this adventure, Trevallis has six months left to live.

Personality:
Motivations/Desires/Goals
 Trevallis sees the unlocking of the mystery of the Preserver Stone as his life's contribution to the Romulan Road To The Stars. Nothing will deflect him from this all-consuming obsession in the time he has left.
Manner:
 Trevallis usually behaves in a withdrawn and distracted manner.



Name: KAHRDAC SUTAI DECARA

Rank/Title: Captain
Assignment: Imperial Navy, IKV Excisor
Position: Commander

Race: Imperial Klingon
Age: 33
Sex: Male

Attributes:
STR - 63 CHA - 47
END - 58 LUC - 49
INT - 58 PSI - 05
DEX - 50

Combat Statistics:
To-Hit Numbers - Bare-Hand Damaged: 1D10 + 7
Modern: 47 AP: 9
HTH: 48

Significant Skills	Rating
Administration	35
Astrophysics/Astronomy	15
Carousing	57
Computer Operation	10
Interrogation	37
Language	
Galacta	40
Orion	20
Leadership	35
Marksmanship, Modern	44
Mechanical Engineering	33
Personal Combat	
Rifle	38
Unarmed	46
Starship Security Procedures	40
Starship Strategy And Tactics	28
Starship Warp Drive Technology	20
Starship Weaponry Technology	47

Distinguishing Personal Characteristics:
None.

Brief Personal History:
Birthplace: Alminiar Research Station, Alpha Quadrant
Kahrdac rose to officer rank as a result of several timely promotions made possible by combat vacancies. He has served along both the Organian Neutral Zone and the Triangle border, and seen combat against pirates on more than one occasion. Although competent, Kahrdac is not an overly imaginative officer.

Personality:
Motivations/Desires/Goals:
Being an Imperial Klingon, Kahrdac has little use for non-Imperial Klingons. He enjoys trying to prove that the "inferior strains" are incompetent, and generally tries to make the lives of Klingon-fusion officers as miserable as possible. He is particularly irritated at having to transport a group of cadets (including Klingon-fusions) when he and his men were supposed to be on extended shore leave.

Manner:
Kahrdac's manner is consistently abrasive and irritating.

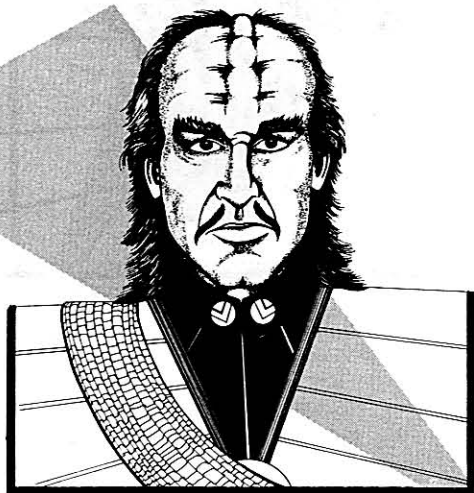

Name: KYRNNA SOLAZARN

Rank/Title: Midshipman
Current Assignment: Imperial Navy, IKV Excisor
Position: Assistant Science Officer

Race: Imperial Klingon
Age: 17
Sex: Female

Attributes:
STR - 45 CHA - 60
END - 40 LUC - 33
INT - 63 PSI - 04
DEX - 52

Combat Statistics:
To-Hit Numbers - Bare-Hand Damage: 1D10 + 3
Modern: 41 AP: 9
HTH: 41

Significant Skills	Rating
Administration	10
Astronomy/Astrophysics	30
Bribery	13
Carousing	10
Computer Operation	27
Ecology	20
Environmental Suit Operation	10
Language	
Galacta	40
Romulan	20
Leadership	10
Marksmanship, Modern	30
Personal Combat	
Dagger	20
Unarmed	30
Physical Sciences	
Physics	20
Zoology	10
Social Sciences	
Klingon History	10
Klingon Law	10
Transporter Operations	10

Distinguishing Personal Characteristics:
Kyrnna wears a star-shaped marking on her left cheek. The emblem commemorates a victory over the Romulans won by her ancestors over a century ago.

Brief Personal History:
Birthplace: Klinzhai
Kyrnna is a recent graduate of the Academy, having completed her own graduation exercise eleven months ago. She is currently finishing up her midshipman's cadet cruise, and will be re-assigned once the *Excisor* returns to Satellite Outpost 2.

Personality:
Motivation/Desires/Goals:
Kyrnna is an unscrupulous individual who will not hesitate to use anyone or anything to advance herself. She is also fiercely competitive. In many ways a model Klingon, Kyrnna is on very friendly terms with Kahrdac.
Manner:
Kyrnna's manner is very detached.

Special Knowledge/Powers:
Kyrnna has been recruited as a covert agent by Imperial Security to keep watch on Captain Kahrdac and other senior ship's officers. In addition to her skills listed above, she has a *Surveillance Skill Rating* of 30.



Rank/Title: STANDARD-ISSUE OUTPOST PERSONNEL

Current Assignment: Imperial Navy, Satellite Outpost 2, K'Tazza VII
Race: Klingon
Age: Gamemaster's Choice
Sex: Gamemaster's Choice

Attributes:

STR - 50 + 2D10	CHA - 20 + 2D10
END - 30 + 2D10	LUC - 20 + 1D10
INT - 40 + 2D10	PSI - 1D10
DEX - 40 + 2D10	

Combat Statistics:

To-Hit Numbers - Modern: 40 HTH: 55	Bare-Hand Damage: 1D10 + 8 AP: 10
---	--------------------------------------

Significant Skills

	Rating:
Administration	10 + 1D10
Bribery	20 + 2D10
Carousing	25 + 2D10
Computer Operations	30 + 1D10
Gaming	25 + 1D10
Interrogation	10 + 2D10
Language	
Galacta	30 + 1D10
Romulan	25 + 1D10
Marksmanship, Modern	40 + 1D10
Personal Combat	
Pistol	35 + 1D10
Unarmed	45 + 1D10
Shuttlecraft Piloting	20 + 1D10
Starship Navigation	30 + 1D10
Starship Sensors	30 + 1D10

Distinguishing Physical Characteristics:

None.

Notes:

Ninety per cent of all outpost personnel encountered will be Imperial Klingons, the rest Klingon/Romulan Fusions. When encountered by the player characters, they will be friendly, remembering their own graduation exercise. Although sympathetic, none will be so bold as to break regulations for the cadets. For a price, however, some outpost personnel may be willing to consider mutually-advantageous "arrangements".



Rank/Title: STANDARD-ISSUE STARSHIP PERSONNEL

Current Assignment: Imperial Navy, IKV Excisor
Race: Klingon
Age: Gamemaster's Choice
Sex: Gamemaster's Choice

Attributes:

STR - 40 + 2D10	CHA - 20 + 2D10
END - 50 + 2D10	LUC - 20 + 2D10
INT - 50 + 2D10	PSI - 1D10
DEX - 60 + 1D10	

Combat Statistics:

To-Hit Numbers - Modern: 45 HTH: 55	Bare-Hand Damage: 1D10 + 6 AP: 10
---	--------------------------------------

Significant Skills

	Rating
Administration	10 + 1D10
Astronomy/Astrophysics	10 + 1D10
Carousing	25 + 2D10
Computer Operations	20 + 2D10
Gaming	20 + 2D10
Interrogation	10 + 1D10
Marksmanship, Modern	40 + 1D10
Personal Combat	
Pistol	35 + 1D10
Unarmed	40 + 1D10
Shuttlecraft Piloting	25 + 2D10
Small Unit Tactics	20 + 2D10
Starship Communications Operations	10 + 1D10
Starship Deflector Shield Technology	10 + 1D10
Starship Navigation	25 + 1D10
Starship Helm Operations	30 + 1D10
Starship Weaponry Technology	10 + 1D10

The *Excisor* crew has been on duty assignment for the last six months without a proper shore leave. Now that the vessel must serve as transport for the exercise team, many officers will be ill-disposed toward the "wretched scum" who are keeping them from their much deserved rest and recreation. A number of the ship's junior members will welcome their passengers, if only as welcome relief from shipboard routine.

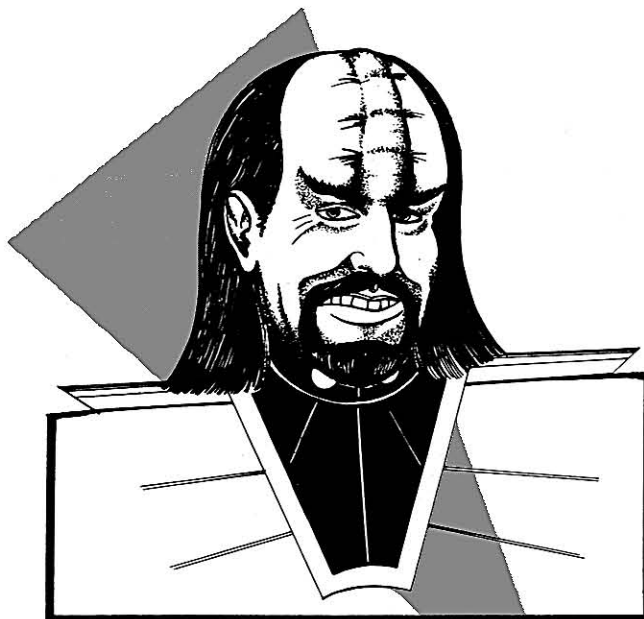

Rank/Title: STANDARD-ISSUE CIVILIAN SCIENCE TECHNICIAN (Total of 3)

Current Assignment: Privately-Funded Research Project, Triangle Zone
Position: Research Assistant

Race: Romulan
Age: Gamemaster's Choice
Sex: Gamemaster's Choice

Attributes:
 STR- 50 + 1D10 CHA - 40 + 2D10
 END- 50 + 1D10 LUC - 40 + 2D10
 INT - 60 + 2D10 PSI - 20 + 2D10
 DEX- 50 + 2D10

Combat Statistics:
 To-Hit Numbers – Bare-Hand Damage: 1D10 +2
 Modern: 35 AP: 10
 HTH: 40

Significant Skills	Rating
Computer Operations	40 + 1D10
Computer Technology	30 + 1D10
Electronics Technology	40 + 2D10
Language, Galacta	30 + 1D10
Marksmanship, Modern	30 + 1D10
Mechanical Engineering	20 + 1D10
Physical Science	
Biology	30 + 1D10
Chemistry	30 + 1D10
Small Equipment	
Systems Operation	40 + 2D10

Attracted by the prospect of discovering new technology based on Trevallis' work on the Preserver Stone, these Romulan scientists were recruited from the civilian sector. For the last year and a half, they have followed Trevallis devotedly. Lately, all have become disillusioned because of the continued failure of their work, with no new hope in sight.



Title: STANDARD-ISSUE SECURITY GUARDS (Total of 4; Originally 6)

Rank/Title: Trinam
Current Assignment: Detached Service Civilian Science Team, Triangle Zone
Position: Security Operatives

Race: Romulan
Age: Gamemaster's Choice
Sex: Male

Attributes:
 STR -60 + 1D10 CHA -40 + 1D10
 END -60 + 1D10 LUC -40 + 1D10
 INT - 60 + 2D10 PSI - 40 + 2D10
 DEX -50 + 1D10

Combat Statistics
 To-Hit Numbers – Bare-Hand Damage: 1D10 + 8
 Modern: 40 AP: 10
 HTH: 50

Significant Skills	Rating
Administration	10 + 1D10
Language, Galacta	40 + 1D10
Marksmanship, Modern	50 + 1D10
Personal Combat	
Pistol	35 + 2D10
Unarmed	45 + 1D10
Personal Weapons Technology	40 + 2D10
Security Procedures	40 + 2D10
Shuttlecraft Piloting	10 + 2D10
Small Equipment Systems Operations	20 + 1D10
Small Unit Tactics	30 + 1D10
Social Science, Romulan Law	20 + 1D10

Providing general security and personal escort protection to Trevallis and his research team, these junior security officers take their duties very seriously. Though unaware of the exact nature of Trevallis' work, each is convinced of its importance. On Tarab VI, these Romulans are assigned to capture live subjects for Trevallis' experiment, which is why they carry energy rods as well as standard Romulan disruptors at all times.

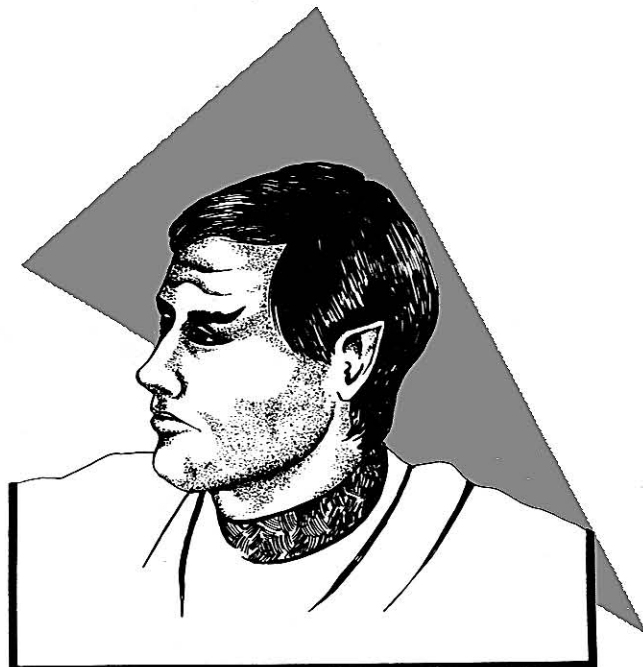

Gamemaster's Notes

HINTS FOR PLAY

TIMELINE

For the gamemaster's reference, the following timeline provides a chronological listing of events leading up to and occurring during this adventure.

-7 years ago

Commander Kameron sutai Rannic begins illegal but lucrative trading with various Orion independents in the Triangle Zone. Newly promoted to centurion, Trevallis is assigned to exploration duty along the edge of space near the Romulan/UFP border.

-6 years ago

Enemies of Commander Kameron charge him with illegal activities, and so he is recalled from his command along the Triangle. Although later acquitted of the charges, Kameron is passed over for promotion and reassigned to a rear-area post. The first Klingon survey team explores the Tarbus system, but discovers nothing of appreciable commercial value. Led by Trevallis, a Romulan landing party explores a previously uncharted planet. On that planet, they discover the ruins of an ancient Preserver settlement and a stone etched with mysterious inscriptions.

-5 1/2 years ago

Working under the tightest security, Trevallis and a select group of Romulan scientists begin to study the Preserver artifact. Trevallis quickly concludes the inscriptions on the stone are chemical formulas that would lead to vastly increased food production if correctly deciphered.



-5 years ago

En route to their new home on Fountainworld, Kyrstal Stallamaine's family is wiped out during an attack by Klingon privateers. One of the few survivors, Kyrstal is turned over to Orion pirates, who take her to the BioResearch Corporation's headquarters on the planet Comstock. Commander Kameron is reassigned to the Imperial Klingon Star Academy as an instructor, an appointment he deeply resents.

During Trevallis' research, a laboratory accident releases an experimental virus into the atmosphere above the research station. At first, there are no discernible effects. Within a week, however, hundreds of the planet's inhabitants are dead from a mysterious and unpredictable disease. Before Trevallis' team can halt its spread, the plague virus wipes out 90 per cent of the population.

-4 1/2 years ago

After Kyrstal makes an unsuccessful escape attempt, her captors decide she would make an excellent undercover agent. Lancelot Worthington III of BioResearch orders her to be trained as a special intelligence agent. Though Trevallis fears he will be sentenced to exile for his part in the plague disaster, he is court-martialled instead. His career in the service now at an end.

-4 years ago

Cadets Kalla Rovashi, Kirlack Illioth, Kuron Treth, Mazrak Hurn, Medan Linzor, and Mijarn Kommora enter the Imperial Klingon Star Academy as first-year officer candidates.



-3 1/2 years ago

Having discovered the nature of BioResearch's real activities in the Triangle, Kyrstal Stallamaine breaks with Worthington and returns to Fountainworld. There, she reclaims her inheritance, having decided to become a freelance spy. Reduced to civilian status, Trevallis manages to obtain unofficial financial backing that permits his experiments to continue outside Romulan space.

-3 years ago

Kyrstallia accepts her first big assignment as a free agent. Working with a Romulan agent, she infiltrates the BioResearch Comstock headquarters to steal industrial secrets for a rival corporation. Trevallis arrives in the Triangle, where he has drummed up support for his work. Having selected a new planet for his headquarters, Trevallis resumes his experiments.

-2 Years Ago

Following a series of successful operations in the pay of both Romulan and Federation intelligence services, Kyrstallia accepts a Klingon assignment. She must uncover the whereabouts of ex-admiral Kradon, who is said to be hiding somewhere in the Imperial Klingon States. Kameron only narrowly avoids further disciplinary action when a cadet in his charge dies as a result of severe punishment Kameron has ordered. Trevallis' latest work goes no better than before. This time, half of his research team dies before the rest can safely escape.

-1 Year Ago

Cadet Mazrak nearly dies in a training simulator mishap. Mazrak blames Master of Cadets Kameron for the accident.

-6 Months Ago

Kyrstallia manages to locate Admiral Kradon, who later eludes the Klingon operatives sent to capture him. The Klingons are nevertheless impressed with Kyrstallia's work. They reward her with a special contact in Imperial Security upon whom she can call for future assistance.

-3 Months Ago

A second failure forces Trevallis' team to move again, causing other intelligence operatives in the area to take note of his presence for the first time. Kyrstallia begins her own private investigation of Trevallis' past and present activities.

-2 Months Ago

Cadets from the Imperial Klingon Star Academy are sent to their respective assignment stations. They await the arrival of their Task Masters and official orders for their final graduation exercises. Kyrstallia learns of the Romulans' arrival in the Tarbus system from an Orion merchant. Convinced that the Romulans are on Tarab to establish a secret military base, she decides to investigate in person.



-1 Month Ago

As a direct result of his work on the Preserver formulas, Trevallis has contracted a fatal illness. He estimates that he has less than six months to live.

-2 Weeks Ago

Kyrstallia alerts her contact in the Klingon Imperial Security to the presence of Trevallis' team on Tarab. For a sizeable fee, she arranges to meet with the Klingons in two weeks to provide information on the Romulans' activities. In exchange for safe passage off Tarab (and to prevent being double-crossed), Kyrstallia also agrees to hand over her file on slaver activities in the Triangle.

-10 Days Ago

Using an Orion trader as transport, Kyrstallia arrives undetected on Tarab. Once safely out of the Tarbus system, however, the Orion trader anonymously warns Trevallis of her presence.

-1 Week Ago

Imperial Security orders Cadet Exercise Group 473 to proceed to Tarab and retrieve the intelligence operative known as "Kyrstal".

-2 Days Ago

Romulan security guards capture Kyrstallia near Trevallis' camp when her vehicle malfunctions in a Tarabian snow storm. Trevallis keeps her alive, saving her for his final series of experiments to begin in a few days' time.

POINTS OF VIEW

In **Graduation Exercise**, the players must accomplish a clearly-defined objective within a specific period of time, using only the skills they possess. Although the premise is simple, **Graduation Exercise** is far from a straightforward adventure module.

There are two factors that can complicate and even disrupt the cadets' graduation exercise. These are the presence of the Romulans and the various personal conflicts between the players. The gamemaster can best approach the adventure as a delicate balance between internal and external forces, each requiring careful attention at all times.

From the players' point of view, there are two possible approaches to the adventure. The players may deal with the exercise on a group basis or individually. The group approach offers the possibility of limited cooperation between the players. With the individual approach, each player character is out to score as many points as possible, with little or no regard for the rest of the team. The game-

master must be ready to handle either approach. He must be equally ready to shift quickly if there is a sudden, unexpected change from one approach to the other during the course of play.

Kameron is formally in command of the group for the duration of the adventure, but his primary role is that of observer rather than advisor or tactical consultant. (He has the authority to act to save the mission if it is threatened by any sign of cowardice among the cadets, however.) Therefore, the gamemaster must avoid the temptation to use Kameron's superior training and experience to extricate players from difficult situations. The cadets are to be evaluated on how they carried out the mission WITHOUT benefit of his assistance.

As for the Romulans on Tarab VI, it must be remembered that their presence there is not officially sanctioned. After Kyrstallia has managed to learn of his activities, the scientist may decide it is time to move on once again. Although the discovery of the Romulans is an unexpected (and for Kameron, a pleasant) surprise, their presence does nothing to alter the basic premise of the mission.

THE MAJOR PARTICIPANTS

Following is supplementary background information on important NPCs who appear in this adventure. The information is for the gamemaster's use only.

COMMANDER KAMERON

Kameron sutai Rannic is an ambitious Klingon with a well-defined goal. As a student of Klingon history and an intelligent observer of Klingon life, Kameron concluded early in his career that very few Klingons live to rise to a position of supreme power and that fewer still live long enough to enjoy it. If the ambitious man is not destroyed by enemies, he could just as easily be betrayed by 'trusted friends'. Klingons who crave power traditionally seek admiralty posts and become deeply involved in political intrigue. Kameron, however, has chosen an alternative course. He will seek wealth rather than power, and security rather than success. Kameron hopes to wring as much personal gain as possible from the *Komerex Zha*, and then quietly slip away with his winnings.

The Commander has managed to organize a group of like-minded political and military figures, with the aim of creating a monopoly on trade in the Triangle Zone. By the judicious use of bribes, blackmail, and coercion, Kameron has managed to direct the flow of illegal contraband (including slaves) into the hands of numerous Orion traders at ports of call such as Kachtulla II and K'Kaar along the Klingon border. Though Kameron was not directly involved in the events leading up to the capture of Kyrstallia, he played a major role in the chain of events that would later lead her to Tarab VI.

With enough wealth amassed, Kameron hopes to one day quietly disappear deep into the Triangle to live out the rest of his days in luxurious obscurity. Very little remains secret in the Klingon Empire, however. Imperial Security has long suspected Kameron's activities (if not his motives), but has lacked the evidence to make a case against him. Security has been able to block Kameron's promotion to Captain, getting him re-assigned to the Imperial Klingon Star Academy to separate him from his operatives.

In response, Kameron has kept a low profile since assuming his role as instructor. He has drawn attention to himself only on those occasions when he has taken out his anger on the hapless cadets in his charge. While his anger is genuine, these actions were calculated to convince Kameron's superiors that perhaps his talents would be better utilized elsewhere.

Kameron's posting as Master of Cadets for Exercise Team 473 may well be the lucky break he desperately needs. Should the group accomplish their mission without any casualties, Kameron may reasonably expect to be rewarded with a transfer to a line command. This, in turn, would permit him to resume his clandestine operations and eventually make his way into the Triangle for good. Should his cadets fail, Kameron will no doubt remain at the Academy, which will buy time for Imperial Security to gather the evidence needed to obtain a termination order against him.

KYRSTALLIA STALLAMAINE

Kyrstal Stallamaine was born on the planet Precipice, the daughter of a wealthy Orion father and a Human mother. Because of her native planet's proximity to the Klingon Empire, Kyrstal (like all Precipians) grew up with a deep distrust of all things Klingon. This prejudice was further reinforced when her parents emigrated to Fountainworld deep in the Triangle Zone, after several minor financial setbacks. Her father hoped that his family ties on Fountainworld would help him start anew with little difficulty. During the journey, however, the Klingons captured their vessel not far from the Federation border. Kyrstal's parents and the ship's crew were killed. Kyrstal and the other few survivors were sold to Orion independents, who in turn delivered them to the BioResearch Corporation on the planet Comstock.



It was not long before Kyrstal's fierce nature and noticeable beauty brought her to the attention of Lancelot Worthington III, chief of the corporation's Comstock holdings. Intrigued by her story (and the prospect of gaining control of her vast inheritance once Kyrstal's identity was proven), Worthington offered her a job. Under the circumstances, the girl had little choice but to accept training as an intelligence operative for the Special Action Division of BioResearch. After training, Kyrstal served Worthington for a year.

When she discovered the extent to which BioResearch was involved in planned assassinations throughout the Triangle, as well as Worthington's real intentions toward her, Kyrstal immediately broke with her employer. Enraged, Worthington ordered her execution. After several of his best assassins failed to return from the assignment, he was forced to rescind the order. Since then, there has been an uneasy peace between the two.

Moving deeper into the Triangle, Kyrstal made her way to Fountainworld, where she managed to regain control of her family's holdings. Using the wealth of her inheritance and her own natural abilities, Kyrstal established herself as an independent agent. Within a short time, "Kyrstallia" (as she now preferred to be known) had made contacts with every known political faction in the Triangle.

She received many offers of employment. On her first assignment, she infiltrated her former employer's offices in order to steal sensitive documents for a rival firm. However, she will work for anyone willing to pay her price. With this as her business philosophy, Kyrstallia has on one occasion worked with Romulan agents against Klingon interests. On another occasion, she worked for the Klingons to locate the

whereabouts of rebel Admiral Kradon, who was in hiding. Although she managed to locate the renegade, Kradon escaped before appropriate action could be taken. He is still at large. Though the mission was technically a failure, Imperial Security was impressed enough by Kyrstal's abilities to reward her with a high-level contact in Imperial Security.

Through it all, Kyrstallia has maintained close watch on slavery operations throughout the Triangle. Whenever possible, she has obtained proofs of direct involvement by individuals. As a form of life insurance and a possible future bargaining chip, Kyrstallia carries with her at all times a computer chip containing all the information she has gathered.

Shortly after Trevallis' arrival on Tarab VI, Kyrstallia learned of it from the same Orion trader who had transported the Romulans to the planet (after Trevallis paid him handsomely to hold his tongue). Kyrstallia suspected the Romulans might be constructing a secret military installation on Tarab in retaliation for a similar Klingon operation already in place. When she brought the information to the attention of her Klingon contacts in the Triangle, they asked her to find out more about the Romulans' activities on Tarab.

Kyrstallia paid the same Orion trader to transport her to Tarab VI. Even as she began her surveillance of Trevallis' camp, the Orion had anonymously alerted the Romulans of her presence on the snowbound planet. (Eager for new opportunities to make money elsewhere, the Orion has long since departed for other ports of call, with no intention of returning for either party).

Shortly after her arrival on the planet, Kyrstallia was captured by Romulan security guards when a sudden snow storm prevented her escape. As the adventure opens, Trevallis is holding Kyrstallia for use in his final series of experiments, which are about to begin.

Understanding the ways of Orions only too well, however, Kyrstallia had wisely taken precautions beforehand. Prior to leaving Fountainworld for Tarab, Kyrstallia had her contact in Klingon Imperial Security inform the Empire of the presence of Romulans on Tarab and of her suspicions concerning their activities there. In addition, she dropped hints about information that would implicate numerous Klingon officers in Orion smuggling operations in the Triangle. In exchange, the Klingons agreed to retrieve Kyrstallia from Tarab in two weeks' time. As a result of these precautions, Cadet Exercise Group 473 was ordered to carry out their mission on Tarbus VI.

TREVALLIS AND THE PRESERVER STONE

Trevallis' career began auspiciously with an early promotion to duty as a member of the Romulan Exploration Division along the fringes of the Star Empire near the Federation border. One of the few science specialists in the area, Trevallis led many survey teams to newly-discovered worlds. On one such occasion six years ago, Trevallis discovered the remains of what was probably a private UFP science team amid the ruins of a Preserver city. Most exciting of all was the discovery of a large stone shard engraved with symbols of obvious Preserver origin.

After numerous failed attempts to decipher the script, Trevallis became convinced the strange markings were not an ancient language but, rather, formulas for chemical compounds. He further believed that deciphering the inscription could eventually yield enormous benefits to the resource-hungry Romulans, most notably in increased food production.

Trevallis was able to persuade the Empire to establish a secret research project with him in command. When one of his laboratory experiments accidentally released a deadly virus that quickly decimated the local population of the planet where he was working, Trevallis was court-martialed. Still convinced that his theories regarding the Preserver Stone inscriptions were correct, Trevallis found private backers to fund his continued efforts. Their only stipulation was that all work be conducted outside the borders of Romulan space.

Trevallis' work centers on the adaptation of the presumed chemical formulas recorded on the stone to create chemical compounds capable of accelerating the reproductive rate of various life-forms used as Romulan food staples. His determination notwithstanding, Trevallis has met with nothing but disappointment and frustration. The key to the Preserver inscriptions continues to elude him. As a result of the laboratory accident that ended his military career, Trevallis is slowly dying. By his own estimate, he has roughly six months left to live.

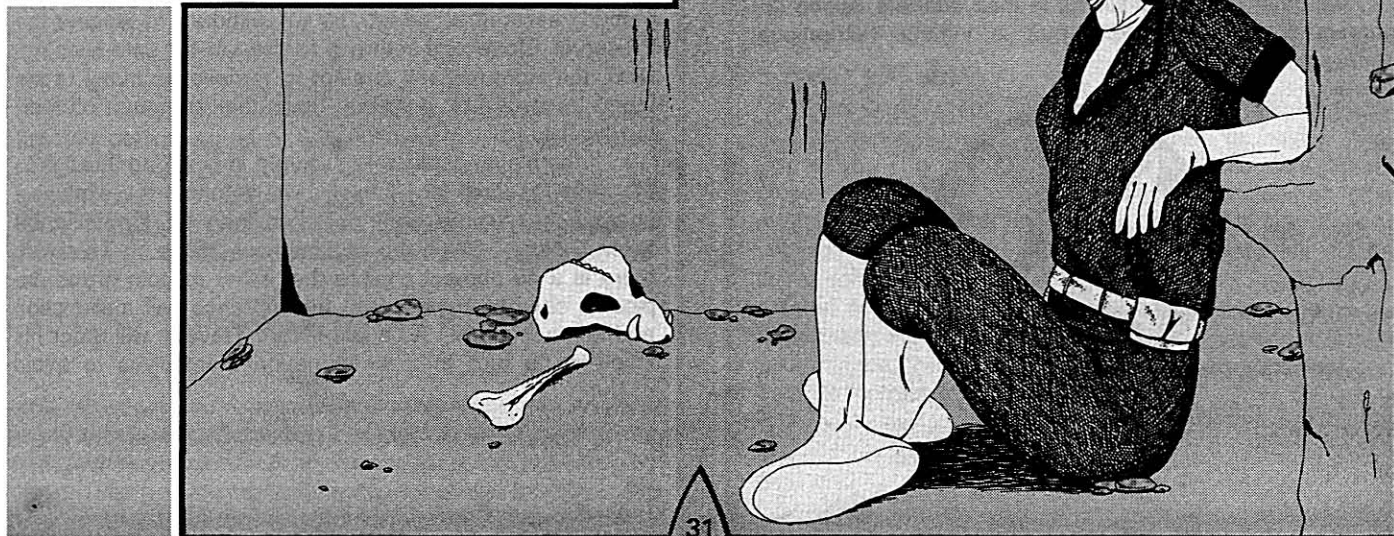

ROMULAN SECURITY AND DEFENSE

INSIDE THE ROMULAN BASE

Having been warned in advance of Kyrstallia's presence, the Romulans are now on the alert for other possible intruders on the planet. Until Trevallis' experiments are concluded two days' hence, increased security precautions are in effect. These are reflected in the following placement of Trevallis' personnel in and about their base:

Perimeter Patrol

One Romulan security guard will be assigned to patrol within 100 meters of the cave entrance at all times. There is a 40 percent chance that he will be in sight if the player characters approach the cliff face near the cave entrance.

Inside The Cave

One security guard is at the cave entrance. A second guard will be at the base security station monitoring movements inside the cave by remote visual links. A third guard will be patrolling the interior of the cave. There is a 20 percent chance (roll percentile dice) that player characters moving into the cave via the underground stream can be detected by either security guard during daylight hours.

Inside The Computer Center

One research assistant will be engaged in preparing automated readouts for use in Trevallis' next series of experiments.

Inside The Research Lab

A second research assistant will be completing a final series of lab tests on samples taken from Kyrstallia, feeding the results into a recording device linked to the main computer. A third assistant will be readying the main experimental lab for work on Kyrstallia.

Trevallis

There is a 50 percent chance that Trevallis will be with the Preserver Stone, examining the inscriptions against notes in his possession. If not so engaged, he can be found transcribing the results of his most recent experiments in his quarters.

Other Personnel

All other personnel will be in their quarters asleep (30 percent chance), or taking part in various recreational activities.



THE ROMULAN DEFENSE

Once intruders have been discovered in the compound, the Romulans will move quickly to protect the more sensitive areas of their base. By pre-arranged signal, two of the security guards will remove Kyrstallia from her holding pit and bring her to the center's experimental lab. The others will position themselves around the computer center and research labs in an effort to guard them at all costs.



Before leaving his post, the guard on duty at the security station will arm the cave's explosive charges. These can now be triggered by Trevallis if it appears the attackers will succeed in capturing the research team. Drawing their weapons, Trevallis' research assistants will position themselves on the roof-tops and in the corridors of the lab and computer centers, taking active part in defense of the installation.

Once Trevallis has made certain Kyrstallia has been properly secured in the lab, he will withdraw to recover the Preserver Stone and return it to the lab for safe-keeping. Next, the Romulan will attempt to retrieve as many of his taped records as possible from the computer center, moving these also to the main lab.

If the player characters succeed in breaking through to the main research lab, Trevallis will detonate the explosive charges by remote control rather than let Kyrstallia be taken. (Note: Given the climactic conditions on Tarab VI, there is a 40 percent chance that either or both of the explosive charges buried near the entrance will malfunction and fail to explode.) As a last resort, Trevallis will order his followers to turn their weapons on themselves to avoid capture.

RANDOM ENCOUNTERS AND EVENTS

This section describes in chronological order a number of possible encounters and events that may affect the outcome of **Graduation Exercise**. Table I outlines random encounters and events that may occur on Satellite Outpost 2. Table II lists events aboard the *Excisor* en route to Tarab. Table III includes events that may take place on the surface of Tarab. Table IV describes possible animal encounters on Tarab.

SATELLITE OUTPOST 2

After receiving their copy of the Mission Plan, some players may decide to use the time remaining before lift-off to seek out information or additional supplies for use during the exercise. If so, the gamemaster should determine whether a random event occurs. Although players will commonly encounter only marine guards and off-duty personnel retiring for the evening, unexpected encounters are possible. For every hour a player is outside his designated quarters, the gamemaster should roll 1D10 against Table 1 and apply the results immediately. Note that a single encounter can be applied to more than one player.

TABLE 1: ON SATELLITE OUTPOST 2

Die Roll	Result
1-2	No Random Event
3-4	Security Check
5-6	Night Revelers
7-9	Work Detail
10	Commander Kameron

Security Check

The player character has encountered an outpost security guard who will ask for an explanation of why the cadet is out of quarters so late at night. If the answer is not convincing, the guard will immediately alert his superiors and place the player under arrest. To determine the result of this encounter, the gamemaster should roll D100-20. If the roll is less than or equal to the average of the player's *CHA* score plus his current *Leadership* Skill Rating, rounded up, the player has been convincing enough to avoid further harassment.

Night Revelers

The player character encounters a group of off-duty enlisted personnel, all of whom are drunk. These revelers will block the player's movements, insisting that he join the party. Should the cadet refuse, the group will react violently, resulting in an open brawl. Security will then arrive on the scene, detaining everyone concerned for the rest of the evening.

Work Detail

A senior enlisted man is organizing a work detail on the base's engineering levels, and a player character happens onto the scene. He is ordered to fall-in and assist with equipment maintenance. From past experience, the cadet knows such a detail is likely to take as long as ten hours to complete (roll 1D10). If he refuses, the NCO is liable to become very hostile. Should the player then agree to accompany the officer, he will be watched at all times. If the detail threatens to continue past scheduled lift-off time, the cadet will be forced to make a run for it to make it aboard the *Excisor* in time.

Commander Kameron

The player character encounters his Task Master, who is on the way to the Officer's Club before turning in. The Commander will demand an immediate explanation for why the cadet is outside quarters. If his response is unsatisfactory, the player character will land in the outpost's detention facility for the remainder of the evening. Resolve the encounter as per the above **Security Check**.

ABOARD THE EXCISOR

In addition to assigned duties during their journey to Tarab, the player characters may encounter special situations aboard ship, and these are described below. While the order and timing of each potential encounter is left to the gamemaster's discretion, at least one check for each member of the exercise group should be made for each day en route to the Tarbus system. The gamemaster will roll 1D10 against Table II. Only one event can be applied to a given player, and the results of the die roll are applied immediately. If the roll results in a random encounter that has previously occurred, treat the result as "No Random Event".

Table II: ABOARD THE EXCISOR

Die Roll	Result
1-2	No Random Event
3-4	Surprise Inspection
5-6	Midshipman Meeting
7	Klin Zha Match
8-9	Special Duty
10	Captain KahrDAC

Surprise Inspection

The Department Head to whom the player character has been temporarily assigned decides to hold a snap inspection. This will include a formal inspection in which the player is expected to properly explain procedures used during his duty watch. In addition, the cadet may have to undergo a station simulator test to evaluate his actions under combat conditions. The results of this inspection are entered in the player's file for later review. Should the Department Head be dissatisfied with the player character's performance, the cadet will have to pull an additional duty watch to "correct deficiencies".

Midshipman Meeting

The player character runs into Krynna Solarzan, a midshipman serving aboard the *Excisor*. Formerly an upperclassman at the Academy, Solarzan is currently on her cadet training cruise. She will attempt to use her rank to intimidate the cadet in any way possible. First, Solarzan demands that the cadet immediately carry out some menial task under her supervision. In reality, she hopes the cadet will object, which would allow her to place him on report. If all else fails, Krynna will try to cause trouble by detaining the cadet as long as possible, thus preventing him from carrying out more important duties.



Klin Zha Match

One of the ship's junior officers invites the player character to the recreation room for a game of *Klin Zha*. In response, the player character must offer something of value as a wager. The officer will then wager something of equal value. Should the player accept the challenge and win, his opponent will not seek retaliation.

The gamemaster can determine the outcome of the match by rolling against the average of the player character's current *Gaming Skill Rating* and *Luc* score, rounded up. Should the die roll be equal to or less than that, the player will have made an acceptable move during the course of the game. Otherwise, he has made a poor move, giving his opponent an advantage. Twelve such good moves are sufficient to win this encounter; an equal number of poor moves will result in the player character's defeat.

The gamemaster should note that although the cadet's opponent will play fair, Klingons enjoy commenting on and criticizing other people's play. The match will be accompanied by the raucous, annoying comments of interested observers. Once begun, the game should last no more than two hours. Roll 1D10 x 10 minutes to determine the time elapsed.

Special Duty

A Department Head orders all departmental personnel to witness the punishment of a junior officer who has committed a minor infraction of the rules. He considers it a "motivational exercise" for the observers. The gamemaster should make a roll against each player's *Luc* score at the start of this session. Should one or more of the rolls fail, the Department Head will call upon the player(s) to help him administer the punishment.

Captain Kahrdac

A player character encounters *Excisor* Captain Kahrdac just coming off duty. Kahrdac is in a very bad mood, and the chance encounter with one of the exercise group only makes him more irritable. Kahrdac demands that the cadet perform an act of obedience (subservience) as proof of his loyalty to the Captain's authority. No matter how demeaning the request, if the cadet fails to comply, the Captain will fly into a rage.

ON TARAB VI

The players will find Tarab VI a very inhospitable place on which to carry out their mission. While they are busy with their operations, the gamemaster should check once every two hours to determine whether a random event has occurred on the planet's surface (assuming the players are acting as a group). If the players have split up, separate checks should be made for each group or individual not included in the main party (as defined by those remaining with Commander Kameron). Roll 1D10 against Table III, and apply the results immediately. Note that there is no limitation on the number of times a random event may occur on the planet.

Table III: ON TARAB VI

Die Roll	Result
1-2	No Random Event
3-5	A Romulan Scout
6	Snow Storm
7	Ice Fault
8-9	Animal Encounter
10	A Virus Detected

A Romulan Scout

In the distance, the player character(s) catch sight of a Romulan security guard on patrol. The Romulan will attempt to draw the player(s) away from the direction of Trevallis' encampment, and then return with reinforcements. (If this encounter has already occurred and the Romulan NPC has eluded pursuit, assume the guard has returned with another security guard to harass the exercise group.)

Snow Storm

The player character(s) encounter a sudden snow squall. The precipitation, backed by high-velocity winds, will do 1D10 damage every five minutes the players are not under cover. A Saving Roll against the *END* score is possible against this damage. Duration will be from ten minutes to one hour (1D10 x 1).

Ice Fault

Surface layers of snow hide a large crevasse covered by thin layers of ice. Any movement on the surface of the ice is likely to cause the layers to collapse. Players failing a successful roll against their *Luc* score will receive 1D10 damage.

Animal Encounter

The player character(s) encounter a Tarabian native life form. Consult the Animal Encounters Table below to resolve the event.

Romulan Virus

The players are travelling through an area heavily-contaminated with viral by-products of Trevallis' many experiments. The player character(s) should make a roll against their END score. An unsuccessful roll will result in increasing weakness and a loss of 1D10 points in END, beginning within the hour and lasting throughout the group's stay on Tarab VI. Because Klingon physiology is less susceptible to the viruses than the Romulan, the cadets will experience a loss of endurance only during their stay on the planet. Once they are safely off-planet, normal healing rates will restore the lost END points.

ANIMAL ENCOUNTERS

Whenever an animal encounter is indicated, the game-master should match the time of day against the Animal Encounter Table to determine which of Tarab's native fauna comes in contact with the players. Roll 1D10, and apply the results immediately. Assume all life-forms to be hostile. All encounters will result in an attack upon members of the exercise group.



Table IV: ANIMAL ENCOUNTERS

Die Roll	Morning	Mid-Day	Evening
1	N'Atolla	N'Atolla	Darronn
2	N'Atolla	N'Atolla	Darronn
3	Darronn	Darronn	Darronn
4	T'Arkonnick	T'Arkonnick	T'Arkonnick
5	T'Arkonnick	T'Arkonnick	Arbonn
6	Arbonn	Arbonn	Arbonn
7	Wennic	Wennic	Arbonn
8	Wennic	Wennic	N'Atolla
9	Darronn	Wennic	T'Arkonnick
10	Arbonn	Arbonn	T'Arkonnick

TARAB VI

The Search Area

As the player characters begin maneuvering within the established search area, they may come across specific terrain features offering clues to recent events on Tarab VI. These features are highlighted on the map of the search area, and briefly described below.

Possible Camp Site 1 (A)

This site lies in a small valley partially sheltered from the severe climate by the surrounding foothills. There is no trace of the agent's camp.

Possible Camp Site 2 (B)

This site lies in an area of partially-forested terrain where native life-forms have been spotted by previous survey teams. There is no trace of the agent's camp.

Possible Camp Site 3 (C)

Located at the edge of a frozen lake, this is Kyrstallia's camp. A hole in the lake surface indicates that the missing agent attempted to supplement her diet with local fresh-water aquatic life.

Rough Terrain Vehicle (D)

Kyrstallia's rough terrain vehicle crashed during a snow storm several days ago. This vehicle may be repairable.

Creature Remains (E)

The remains of several different Tarab wildlife are uncovered in a small defile. An examination of the carcasses reveals that each has been dissected with skilled precision.

Fresh Blood (F)

The presence of fresh blood-stains and patches of white fur on the snow point to a recent attack by one of Tarab's native life-forms. Tricorder analysis of the evidence reveals that the bloodstains are Romulan in origin. The fur samplings are identified as those of an N'Atolla. (This is the site of an attack that cost a Romulan security guard his life prior to the start of this adventure.)

A New-Cut Grave (G)

This is the grave of the Romulan guard killed in the attack by the N'Atolla (see above). The grave itself is a crude cairn hollowed out by disruptor fire and covered with ice-covered boulders.

A Boiling Stream (H)

A player character comes upon a small stream running north to south that, far from being frozen-over, has a surface temperature at boiling point. Trevallis' many experiments have created this strange anomaly. His team has been dumping the chemical and radioactive by-products of their experiments into the stream where it originates in their cave to the north. These wastes have heated up the water.

Although radiation levels in the stream are high, player characters can move outside a 15-meter radius without danger. Beyond this zone, there is a one-in-ten chance of suffering radiation poisoning from exposure to the stream's higher-than-normal radiation level. For every ten minutes a player is within the danger zone, the gamemaster should roll 1D10. A roll of 10 will result in the player's contracting radiation sickness. Thereafter, the gamemaster should roll 1D10 for every half hour of exposure, applying the results as damage against each exposed player's weakest physical attribute. If the player character(s) receives proper medical treatment aboard the *Excisor* within 48 hours, the damage can be totally reversed.

Creature Combat (I)

The player character(s) discover an N'Atolla and an Arbonn locked in fierce combat. The animals are not aware of the player's presence unless he moves within 50 meters of them. Should any player character enter that zone, make appropriate rolls against the character's LUC score. If the roll fails, the creatures are alerted to the cadet's presence, and they will break off combat. At this point, the gamemaster should make two additional rolls using 1D10, one for each creature. A roll of 1-3 will result in that particular creature attacking the player character(s).

A Curious Bottle (J)

A half-empty bottle of alien origin is discovered in the snow near a small wooden copse. Tricorder readings show the contents to be Romulan ale of considerable age. Should the players fail to scan the contents further, they will not uncover traces of a Romulan poison deliberately placed in the drink as a precaution against other intruders on the planet.

Stream Entrance (K)

The underground stream running the width of the Romulan base camp empties out of the frozen hillside at this point. Players may attempt to move up this stream by entering the narrow tunnel along the hillside. The stream extends underground 150 meters before opening out into the main cave, which houses the enemy research facilities. Should any player so enter the stream, the gamemaster must check against possible radiation sickness as per **A Boiling Stream**.

A Malformed Corpse (L)

The remains of a mutated Wennic are found in a shallow, uncovered pit. An unsuccessful experiment by Trevallis caused its mutation and death.

The Romulan Camp (M)

The cave entrance to the Romulan research center is located some 15 meters up the side of a low hill.

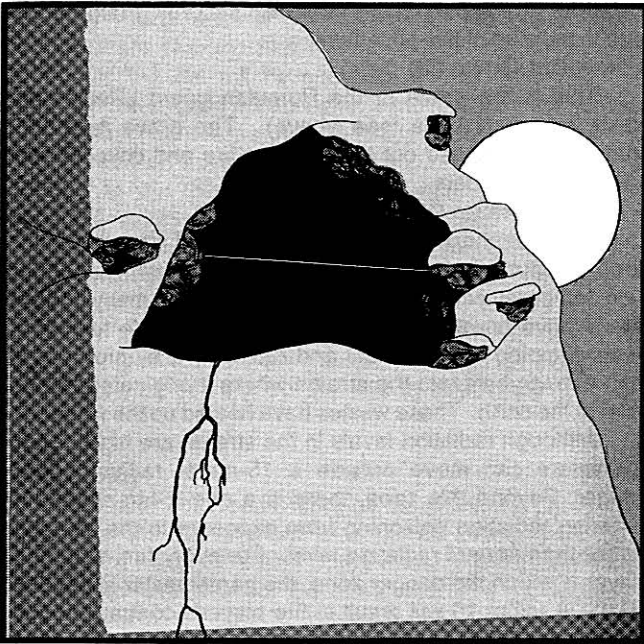

KRYSTALLIA'S CAMP

Once the players have reached the scene of Kyrstallia's camp, they discover clear evidence of a recent attack on the site. First, they find the body of a Romulan (one of the research team's security guards who was killed by Kyrstallia in the attack on her camp). This immediately reveals the identity of the attackers, if not the reason for the attack. An examination of the body indicates the Romulan died as a result of Kyrstallia's skill with her shathra weapon.

There is other important evidence that can be uncovered in and about the camp site. Inside Kyrstallia's emergency shelter is a case of Saurian whiskey, as well as several Klingon light tubes (similar to those used by the cadets themselves). Scattered outside the shelter are numerous triangular tokens whose origin is the Klingon pleasure port Razor's Edge. Among these is a flat, palm-sized coin – an Imperial Security tracking device that the players can use to locate the agent's whereabouts. Footprints around the campsite indicate the presence of several individuals. In an effort to confuse would-be rescuers, the Romulans have left three different sets of prints moving in three different directions. However, if the tracer is activated, it will direct the players due west toward the Romulan research center. The gamemaster should note that, because of the presence of fresh blood in the area, there is a 40 percent chance of drawing a hostile predator into the area. Once the players have begun their examination of the camp, the gamemaster should roll D100. Treat a roll equal to or less than 40 as equivalent to an Animal Encounter (see the Animal Encounter Table to resolve the action).

JUDGING THE EQUIPMENT

Following are descriptions of the equipment, weapons, and other gear used in this adventure.

COLD WEATHER GEAR

This is standard-issue arctic environment clothing adapted to Klingon needs, which is available for all Klingon players and NPCs in this adventure. Cold-weather gear worn by Romulans and Kyrstallia will be non-military issue, obtained by various means from private civilian sources. Despite the protection such clothing normally provides, players exposed to surface conditions on Tarab for more than a brief period of time will suffer frostbite and related exposure effects.

COMMUNICATORS

Kyrstallia has a standard Klingon communicator adapted for use in the Tarabian climate. There is no chance of instrument malfunction. This communicator is used to monitor possible Romulan transmissions ONLY, and no off-world communication is possible with the device. Kyrstallia has no need for off-world communication, as she made arrangements for transport off-planet prior to her arrival.

Exercise team communicators are effective only for speaking to one another on limited band frequencies. Once the exercise has begun, no communication with the *Excisor* is possible. The gamemaster should check for

possible instrument failure (as per **Tricorders** below), except that checks should be made every second time a communicator is being used.

COMPUTER TAPE

Approximately thirteen centimeters square, this micro-recorder tape contains the results of Kyrstallia's investigations of the illicit slave trade in the Triangle zone. If made common knowledge, the names and dates on this tape could do serious political harm to a number of highly-placed Klingon and Orion planetary leaders, officers, and politicians. Kyrstallia collected this information over several years' time.

DISRUPTORS

The Klingon disruptors available aboard the *Excisor* are either Mark I or Mark II types. The Romulan version found among Trevallis' men are old-style Klingon Mark I's. When used in the severe environment on Tarab, either type is subject to possible breakdown. Whenever a Klingon weapon is used, the gamemaster must roll 1D10. A roll of 1-2 indicates a malfunction, rendering the weapon temporarily useless. The same is true of Romulan disruptors, except that a roll of 1-3 results in a malfunction. Klingon weapons can be repaired if a Skill Roll against the character's rating in *Personal Weapons Technology* is successful. Having once malfunctioned, Romulan weapons cannot be repaired.

EMERGENCY SHELTER

Used by Kyrstallia during her stay on Tarab VI, this plasticene emergency shelter resembles a Terran igloo, and is of Federation design. The unit is equipped with a self-contained life-support system that provides heat and light for up to 100 standard hours. Players with appropriate *Trivia* skills may note markings on the shelter's outer surface, indicating that the unit came from Comstock in the Triangle Zone. Additional markings identify the equipment kit as belonging to a Federation merchant vessel. (This shelter is part of a cargo sold to BioResearch Corporation by Orion raiders, which Kyrstallia appropriated for her own use some time ago.

ENERGY ROD

This Romulan version of an old-style Terran shock prod is employed by Security to quell disturbances in situations where a heavier show of force would be inappropriate. Trevallis has used the rod to manage unruly animal subjects for his experiments.

If employed against a humanoid opponent, the device has a variable setting that can deliver between 1-10 points of damage (roll 1D10) upon contact. If used in a closed environment where life-support systems are operating, the device will work. If used in the open, the device is subject to possible malfunction due to the extreme cold. If the rod is used outside the confines of the research center, the gamemaster must first roll 1D10. A result of 1-2 indicates malfunction, although operation can be restored following a successful roll against an individual's *Small Systems Operations* Skill Rating.

ENVIRONMENTAL SUITS

Self-contained environmental suits are standard issue aboard all Imperial Navy vessels. Although these protect against even the harsh environment of Tarab, they are bulky and cumbersome, lacking many of the refinements found in their Federation counterparts. An individual using such a suit must pay double his normal AP costs for all activities.

LIGHTING SPHERES

Each 30 centimeters wide, these lighting spheres are equivalent to the lighting panels used by Federation cultures. Internal anti-gravity units allow the spheres to hang suspended at varied heights. The Romulan research center is brightly illuminated by dozens of such spheres. Players making a successful roll against appropriate *Trivia* skill ratings may recognize these to be of civilian manufacture.

LIGHT TUBES

These are plastic, disposable rods ten centimeters in length, containing a mixture of reactive chemicals. When shaken vigorously, the chemicals interact to produce strong illumination for up to six hours. The tubes are used by Klingon ground forces and are found in standard planetary survival kits.

PERSONAL COMBAT BLADE

Treat this weapon as a standard blade or sword, except that it will do 4D10 damage.

PRESERVER STONE

The product of an ancient race known only as the Preservers, this rectangular block of seeming marble is Trevallis' key to unlocking the secrets of an alien technology. Etched across the multi-colored surface are characters in an unknown, flowing script. Trevallis has labored long and hard trying to decipher them. The stone is approximately one meter high and half as wide. It is scorched on one side, and the upper left hand corner has been broken off. The stone is obviously only a remnant of a much larger, now destroyed stone.

RAZOR'S EDGE TOKENS

The small, triangular tokens found among Kyrstallia's possessions originate from a pleasure planet known as Razor's Edge. This luxury world located deep within the Klingon Empire is famous as a port of call offering an abundance of every imaginable diversion. The tokens discovered on Tarab are used as a medium of exchange on Razor's Edge. Few officers, let alone enlisted men, have ever seen more than a handful of these tokens at any one time. The tokens are generally awarded only to members of the more influential family lines for special services to the State.

Each is approximately two centimeters wide. The edges are razor-sharp (in keeping with the Klingon saying that the only good currency is the kind that draws blood). Player characters making successful rolls against their individual Skill Ratings in *Carousing* will recognize the coins for what they are. They belong to Kyrstallia, who obtained them as compensation for a previous assignment. She carries them for use as very effective bargaining aids when dealing with Klingon agents in the Triangle.

ROMULAN ALE

A case of this highly-intoxicating liquid is among the provisions carried to Tarab by Trevallis' research team. Note that the ale is not standard, military-issue but was purchased in the civilian sector. Prior to disembarking, the Romulans made a deal for the ale with the Orion captain who transported them to Tarab VI. There are no labels or other noticeable clues to its origin.

Drinking from the bottle of ale that is laced with poison will not be fatal, due to the limited effectiveness of the poison in the Tarabian climate. Should any player character ingest the poisoned liquid, the gamemaster should roll against the individual's LUC score, subtracting 20 points from the roll. If the adjusted score is equal to or less than the individual's current LUC score, the player character will take 1-10 damage points (roll 1D10), which can be distributed against one or more physical attributes. If this roll fails, the damage is doubled. The victim will begin to feel effects from the poison within ten minutes. Note that damage inflicted here is not permanent, unless the damage inflicted is too severe at the outset. The individual will be able to return to his former attribute levels once he has returned to the *Excisor*.

ROUGH TERRAIN VEHICLE

This is a small, one-man anti-gravity vehicle designed for rapid movement over broken terrain. The vehicle's shell can withstand up to 80 points of damage. Used in either a hover or ground-hugging fashion, the vehicle can reach a maximum of 120 kilometers per hour. Successful rolls against a player character's Skill Rating in *Mechanical Engineering* or any appropriate *Trivia* skill will reveal the vehicle to be of Orion design and construction. When discovered, Kyrstallia's vehicle is inoperative. The craft malfunctioned several days ago due to the cold, leading to Kyrstallia's capture.

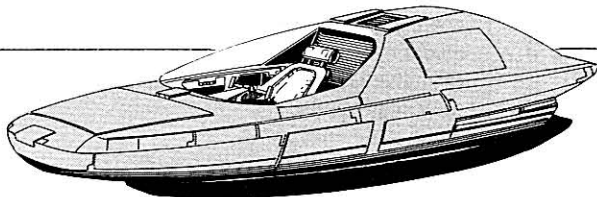

SAURIAN WHISKEY

Though not as famous as Saurian wines and brandies, this very potent alcoholic beverage has a longer-lasting effect on humanoid species. An aged (and very expensive) bottle of the whiskey will be uncovered among the ruins of Kyrstallia's camp. Its origin can be identified by players who make successful Skill Rolls against their *Carousing* skill ratings.

SHATHRA

The shathra is a hand-held weapon, hexagonal in shape, made of a tungsten-duralloy compound, serrated and barbed along its edges. Used by native hill tribes among the Orion colonies on Rigel VII, the weapon is a favorite of Kyrstallia, who is very competent in its use. The shathra is generally employed at ranges of up to 50 meters, striking its target for 3D10 damage.

TRICORDERS

All exercise personnel will be equipped with standard-issue Klingon tricorders. Under normal conditions, these function normally, as described in *The Klingons* supplement. Due to the frigid environment on Tarab VI, there is a one-in-six chance that a tricorder may malfunction as a result of the extreme cold. Whenever a player attempts to make use of a tricorder in an exposed area, the gamemaster should roll 1D10. A roll of 1-2 will indicate a malfunction. Player characters may attempt to repair the device by making successful rolls against Skill Ratings in *Small Systems Operations*.

Note: While it is normal in all other respects, Kameron's tricorder also contains a built-in explosive device for use in emergencies. The Commander can trigger this charge by entering a three-digit code known only to him into the device. After the code is entered, there is a ten-second delay, indicated by a high-pitched whine. Once activated, nothing can countermand this build-up toward activation. The resulting explosion will do 6D10 damage to anyone within a 30-meter radius. Should one of the player characters obtain the device, a successful roll against his Skill Rating in *Mechanical Engineering* or *Small Systems Operations* will reveal the true nature of Kameron's tricorder. A successful roll against the character's LUC score is necessary to activate the explosive. If the hidden explosive is to be used at any time, the gamemaster should check against possible malfunction just as for a normal tricorder.

VEGAN TOBACCO

A luxury item in the Empire, Vegan tobacco generally contains a mild narcotic native to the planet. Treat ingestion of 24 grams as equivalent to an injection of Pain Blocker lasting for two hours.

TRACER

Used by Klingon security teams, the tracer is a small, palm-sized, metal sphere resembling a flattened coin. It can home in on a signal transmitted by a corresponding transducer carried by another individual. Any member of the exercise group (including Kameron) who makes a successful roll against his current Skill Rating in *Security Procedures* can activate the tracer. Once activated, it can pick up signals as distant as 50 kilometers. Using the tracer, a character could determine Kyrstallia's location in the Romulan camp.

JUDGING PLAYER PERFORMANCE

GUIDELINES

In one sense, judging player performance in this adventure is very straightforward. Either the players survive or they do not. Assuming that the players do survive, each individual cadet's success must be evaluated to determine whether he will be specially rewarded at the close of the mission. In the role of Kameron, the gamemaster should judge player performance according to the following criteria.

1. Was the graduation exercise carried out to completion according to the instructions in the mission plan?
2. How well did the players react to unusual or changing conditions once the adventure commenced?
3. To what degree did the players act independently of Kameron's support in determining the outcome of the mission?
4. Did the players utilize their specific skills to the best advantage in the various situations?
5. To what degree were players consistent in their approach to accomplishing their task?
6. Were the players able to grasp the full significance of the Romulan presence on Tarab?
7. Did the players make and then act upon any false assumptions concerning the nature of their mission?
8. Did the players cooperate with or compete with one another?
9. Did the players behave with imagination and originality in the course of the adventure?
10. Did the players ever subject their mission directives to their own interpretation, either individually or as a group?

EVALUATION RESULTS

Using the above (or similar) guidelines, the gamemaster may use any grading system he wishes to assess player performance. On a scale of 0 - 100, the gamemaster can use the following table to evaluate overall player performance.



PLAYER EVALUATION TABLE

Score	Result
0-10	The player has performed poorly and will not be recommended for graduation.
11-25	Performance is judged nominal at best. While the cadet will be passed on for graduation, it is recommended that he be given continued "motivational instruction" during his cadet cruise.
26-50	The player has acted within the expected normal range. Although he has shown little special ability or effort during the exercise, the cadet's performance was adequate to avoid negative recommendations in his service file. Graduation is approved.
51-80	The cadet has done exceptionally well during this mission. He has shown both leadership and initiative, which earns him a commendation on his service record. Graduation is approved.
81-90	The cadet's performance during the graduation exercise was outstanding. He has proven himself an asset to the Empire. Not only will he be recommended for graduation, but will also be permitted to select the branch of the service for his upcoming cadet cruise.
91+	Same as above. In addition, the cadet will receive an immediate promotion of two steps up (rather than the traditional one step up) upon completion of his cadet cruise.

POSSIBLE REWARDS

If the player's performance on Tarab VI is considered above and beyond the call of duty, the gamemaster may elect to reward the cadet in some of the ways described below.

At Kameron's discretion, one or more of the players may be awarded the rank of 'tai'. This honor is witnessed by members of of the ship's company, and confers renown on the cadet's family and respect from officers and crew.

To celebrate the cadets' rite of passage, Captain Kahrdac invites them to dine with his officers. During the celebration, the cadets are named honorary members of the ship's company, which is far more than just a token of esteem. Kahrdac places considerable emphasis on loyalty to one's Commander and vessel, in return for protection in kind. Should anyone threaten or harm a member of his crew, Kahrdac will consider it a personal affront to be personally avenged. Further, he believes that "once a crew member, always a crew member". In this situation, Kahrdac's racial bigotry does not apply.

At the gamemaster's discretion, Kahrdac may become uncharacteristically generous and offer to confer the "Captain's Pleasure" on one or more more cadets. The player character(s) may make any reasonable request of the Captain, who will fulfill it immediately. Such dispensations may include personal weapons or blades, the creation of a specially-designed uniform or set of body armor, the striking of a special commemorative decoration, or even the adoption of a unique personal title that the individual will bear for life.

Kahrdac may distribute weapons, goods, and personal effects 'liberated' from the Romulan camp as mementos for the players. This presumes, however, that something of equal value will be offered the Captain of the *Excisor*.

POTENTIAL OUTCOMES

Given the free-form nature of **Graduation Exercise**, resolution of the adventure will depend largely on assumptions made by the players and their reactions as these assumptions are proven or disproven. In one sense, **Graduation Exercise** can be won or lost before the players ever set foot on Tarab VI.

One possible outcome of the adventure is the loss of one or more cadets on the planet's surface, due to beasties and bad weather. With enough prior planning, cooperation, and a certain amount of luck, this should be avoidable. While conditions on Tarab are far from pleasant, they can be overcome.

Once it has been determined that the Romulans are on Tarab, the nature of the mission changes dramatically. With the size, location, and purpose of the enemy unknown, the risk of death increases accordingly. Matters will be further complicated by Kyrstallia's refusal to leave without her information file. If the contents of this tape are made common knowledge, the scenario is further complicated. Kameron will attempt to prevent possible incriminating evidence against him from falling into the wrong hands. Thus, players may wish to carefully review the parameters of their mission with the following points in mind:

While the mission plan calls for the safe return of the agent Kyrstal, there is nothing to indicate that safe return of Master of Cadets Kameron is also mandatory to a successful mission.

Players may wish to question which would be more important to Imperial Security: the safe return of the intelligence agent or the information in her possession.

Should Commander Kameron attempt to use force to prevent the safe return of Kyrstallia or her information, the players may question to what extent they are bound by obedience to his authority.

Perhaps one or more of the players learns the nature of Kyrstallia's tape, and the players deduce the reason for Kameron's concern about the information it contains. The group may decide to strike a bargain with Kameron in exchange for their silence. What kind of bargain might they devise? How binding will it be, and what guarantees can the player characters expect?

ADAPTING TO ON-GOING CAMPAIGNS

Following are suggestions for incorporating this adventure into a campaign already in progress.

ALTERING GROUP COMPOSITION

As described in the **Cast of Characters** section, the size and composition of the exercise group reflects current conditions in the Academy. The make-up of the exercise team is meant to be as balanced as possible. If desired, the gamemaster is free to increase or decrease the group size or to alter the gender and/or racial mix. The gamemaster may also decide to create the group from a single racial background or gender to minimize (or maximize!) potential conflicts.

SECURITY REPORTS

As the adventure unfolds, the gamemaster may wish to take note of any of the player characters' attitudes or actions that might be of interest to Imperial Klingon Security. These notes can be recorded in a continuing security file that will follow the cadet throughout his career.

FUTURE ASSIGNMENTS

Using the procedure described in **The Klingons** supplement, the gamemaster may wish to determine each cadet's upcoming cadet cruise assignment. Assuming that one or more of the player characters draws an assignment to the Imperial Navy, the gamemaster may assign some players to the crew of the *Excisor*. The vessel will be on a new duty assignment once its crew returns from shore leave.

DESIGNER'S NOTES

Graduation Exercise is unlike other *STAR TREK* adventures, departing from the norm in several respects. The first distinction involves the characters. Although Klingon cadets are chosen for their great potential, they still lack much of the necessary shrewdness, calculation, and sheer luck that comes only with experience. Therefore, Klingon cadets are not expected to behave like regular line officers. Role-playing them as anything more than fledglings misses the whole point of the adventure.

Another distinction concerns the adventure's operating conditions. In most adventures, players can avail themselves of a starship's vast resources and manpower. In **Graduation Exercise**, the players can draw only on their skills and what can be carried on their backs. Nor can they depend on cooperation or assistance from their comrades in this situation.

Finally, **Graduation Exercise** is distinguished by the risk of death it poses. Players should be warned that the chances of death are higher than in other adventures they may have role-played. While all the cadets have an equal chance of surviving the mission by successfully applying their skills and ingenuity, each is just as likely to fail.

Such is the Klingon way. Only those best suited to command will survive.

Four long years you've drilled and studied and trained. More than once you almost gave up, but somehow, you kept on trying. You've taken all the punishment and all the pain the Empire's best could throw at you, and somehow survived it all. You're the one in a hundred. You're one of the survivors. Now at the age of sixteen, only one thing stands between you and your final goal. Only one last assignment to be completed, and then, at long last, you and your comrades will receive your commissions as officers in the Imperial Klingon Navy. After what you've been through, your task seems incredibly simple. Just hop over to a small backwater planet in the Triangle, and bring back an agent Imperial Security needs to question. Simple... except the Romulans might have other ideas about the matter...

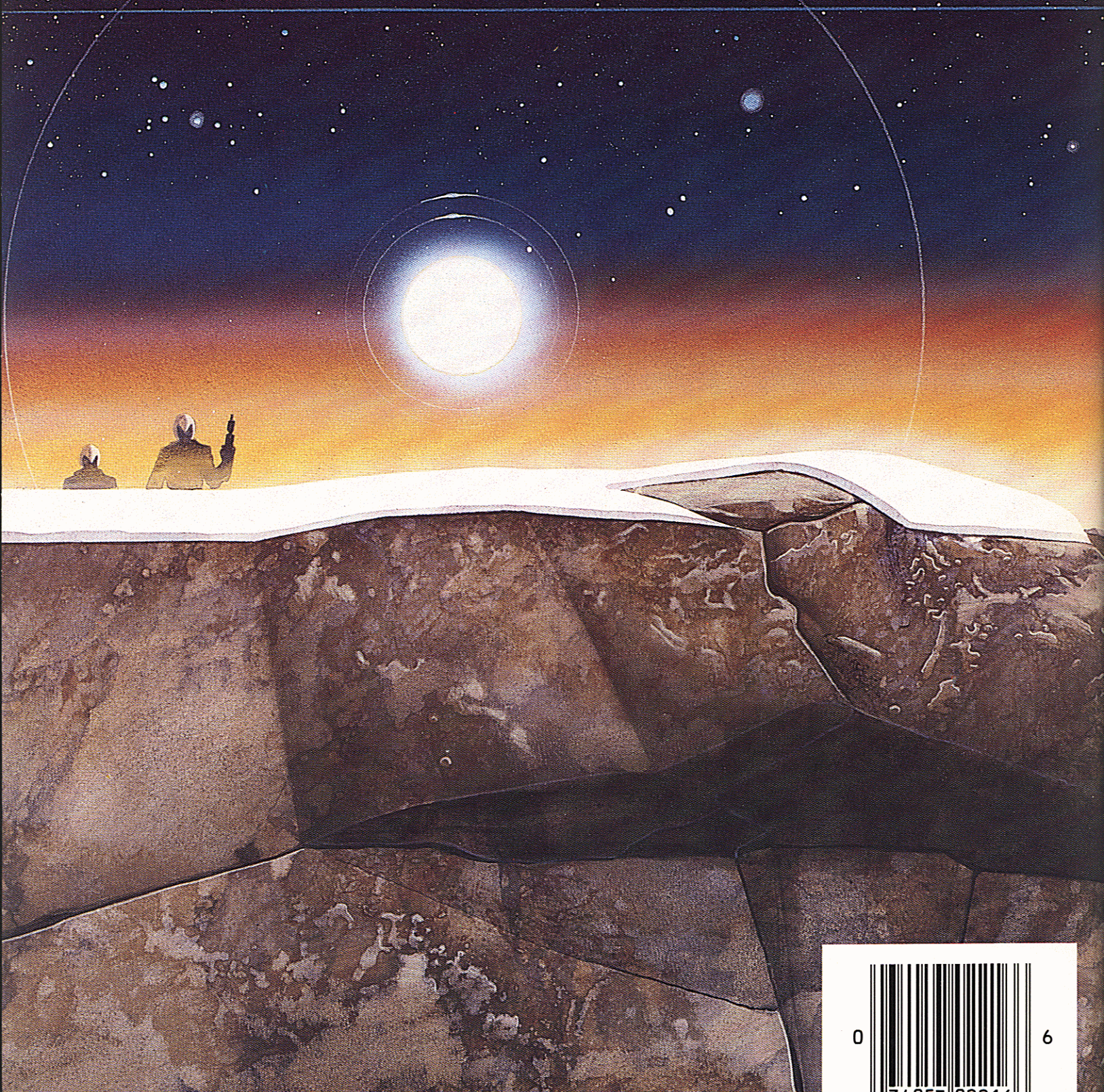

0 6



34057 02216

ISBN0-931787-03-3 FASA800